

## Introduction

Dear user,

This manual provides the user of the Spierings folding crane SK599-AT5 with information concerning the truck's construction, function and operation. Also detailed, technical descriptions and maintenance instructions are given in the maintenance section of this manual.

### **SPIERINGS MOBILE CRANES**

P.O. Box 24  
5340 AA OSS  
The Netherlands

Merwedestraat 15  
5347 KZ OSS  
The Netherlands  
Fax +31 412 67 12 20

Phone number daytime: +31 412 69 77 77

Phone number evening time: +31 655 78 24 85

[www.spieringscranes.com](http://www.spieringscranes.com)

© 2014 Copyright Spierings Mobile Cranes. All rights reserved.

No part of this publication may be reproduced or published, in any form or in any way, by print, photo print, microfilm or any other means without prior permission from the manufacturer.

## Liability clause

This liability clause was added to prevent possible miscommunication.

### ARTICLE 1. USE

The Spierings truck may only be used for the designated purpose, and in the manner as laid down/described in the manual and possible additions thereto.

Any other than the designated use and/or any other manner of operation than laid down/described in this manual and possible additions thereto, and/or action inconsistent with the previous, will explicitly invalidate any guarantee claim as well as any liability for damage, consequential damage and future damage, by any reason and for no matter what.

Operating the Spierings truck is only permitted by people, who have the relevant expertise and a valid driving license for driving a heavy truck, and who are physically and mentally capable of properly carrying out the work involved.

In case of the additions to the manual, the user/operator/driver of the Spierings truck must be notified thereof immediately, and the additions must be added to the manual.

### ARTICLE 2. SAFETY

For safety reasons, the user/operator/driver must strictly comply with the instructions in the manual and possible additions thereto.

The user/operator/driver must keep strictly to the lifting specifications as indicated on the Spierings truck/crane, in the manuals and the additions thereto.

If at any work site of the Spierings truck/crane the safety rules and regulations are more strict than those laid down in the manual, or possible additions thereto, these stricter rules are to be complied with under penalty of expiry of the guarantee and with exclusion of every liability.

The Spierings truck manufacturer explicitly warns the user/operator/driver and/or bystanders, to stay out of the Spierings truck/crane's danger zone.

If any unexpected situation, by whatever cause, occurs during use and/or operation of the Spierings truck, please contact your technical department or Spierings Service immediately.



















### ARTICLE 3. WARRANTY

Without previous written permission of the Spierings truck manufacturer, it is forbidden to carry out modifications and/or welding at or on the Spierings truck.

Systematic maintenance and periodic inspections must be carried out according to the manual and possible additions thereto.

Deviating from these instructions without prior written consent of the Spierings truck manufacturer 's, turns every guaranty claim invalid as well as every liability for damage, consequential damage and future damage, by any reason and for no matter what.

## Explanation of the used symbols

	Information!		Toxic substances!
	Wear safety glasses!		Dangerous for hands!
	Wear safety gloves!		Do not come in turning radius!
	Wear safety shoes!		Corrosive substances!
	Wear a helmet!		Electric voltage!
	Wear a safety harness!		Environmental hazard!
	Check / test!		Caution!
	Incorrect!		Danger of slipping!
	Good!		Entrapment hazard!
	Conditions		Fire hazard!

## Table of contents

### Introduction

<b>Liability clause</b> .....	II
<b>Explanation of the used symbols</b> .....	III
<b>Table of contents</b> .....	IV
1. General data .....	1-1
1.1. Dimensions and weight.....	1-1
1.2. Drive line.....	1-1
1.3. Steering .....	1-2
1.3.1. Road steering .....	1-2
1.3.2. Off-the-road steering .....	1-2
1.4. Suspension.....	1-2
1.5. Braking system .....	1-2
1.6. 4-Point outrigger system.....	1-2
2. Introduction to the truck.....	2-1
2.1. Get to know the truck.....	2-1
2.2. Keys.....	2-2
2.3. Truck cab .....	2-3
2.3.1. Fuse box.....	2-4
2.3.2. Central console .....	2-5
2.3.3. Tachograph .....	2-8
2.4. Engine cowling .....	2-9
2.4.1. Left-hand engine cowling.....	2-10
2.4.2. Right-hand engine cowling .....	2-10
2.5. Outriggers.....	2-11
2.6. Work lamps.....	2-12
2.7. Storage box .....	2-12
2.8. Rear toolbox .....	2-13
2.9. Truck ladder.....	2-13
2.10. Reverse drive camera.....	2-13
2.11. Side view camera (optional) .....	2-13
3. Operating the truck.....	3-1
3.1. Doors .....	3-1
3.1.1. Windows.....	3-1
3.1.2. Ashtray .....	3-1
3.1.3. Getting in .....	3-1
3.2. Seats .....	3-2
3.2.1. Seat adjustments.....	3-3
3.2.2. Seat belts .....	3-3
3.2.2.1. Fasten seat belt .....	3-4
3.2.2.2. Loosen seat belt .....	3-4
3.2.2.3. Check seat belts .....	3-4
3.2.2.4. Cleaning seat belts .....	3-4
3.3. Wing mirrors .....	3-5
3.4. Sun blinds.....	3-5
3.5. Storage room .....	3-5
3.6. Battery chargers remote control batteries.....	3-6
3.7. Windscreen washer reservoir .....	3-7
3.8. Fire extinguisher .....	3-7

3.9.	Control panel .....	3-8
3.9.1.	Indicators.....	3-21
3.9.2.	Main screen.....	3-23
3.9.2.1.	Main screen: General screen.....	3-23
3.9.2.2.	Main screen: Differential indication screen .....	3-27
3.9.2.3.	Main screen: Information screen .....	3-28
3.9.3.	Display gear box.....	3-29
3.9.3.1.	Regular messages display gear box.....	3-29
3.9.4.	Malfunctions in the gear box.....	3-30
3.9.4.1.	Error messages display gear box .....	3-30
3.9.4.2.	Error messages display gear box .....	3-32
3.9.4.3.	Active error message(s) display gear box.....	3-32
3.9.4.4.	Error history display gear box.....	3-33
3.9.5.	Control panel steering system .....	3-33
3.9.5.1.	Keys control panel steering system .....	3-34
3.9.5.2.	Display control panel steering system .....	3-36
3.9.5.3.	Structure main menu control panel steering system.....	3-37
3.9.6.	Malfunctions in the steering system .....	3-38
3.9.6.1.	Read malfunctions on the control panel of the steering system.....	3-38
3.9.6.2.	Resetting error history control panel steering system.....	3-40
3.10.	Signalling direction indicators .....	3-41
3.10.1.	Malfunctions direction indicators .....	3-41
3.10.2.	Operating system signalling direction indicators.....	3-42
3.11.	Climate control.....	3-43
3.11.1.	Control panel .....	3-43
3.11.2.	Use of the air conditioning .....	3-44
3.11.3.	Dehumidification of the air .....	3-45
3.12.	Navigation and multimedia system (DVD/CD-player/radio) .....	3-45
4.	Driving.....	4-1
4.1.	General.....	4-1
4.2.	Running-in the vehicle .....	4-2
4.3.	Before driving .....	4-4
4.3.1.	CHECKLIST: Before driving on public roads .....	4-4
4.3.2.	CHECKLIST: Check vehicle lights.....	4-6
4.4.	Start diesel engine truck .....	4-7
4.4.1.	CHECKLIST: Start diesel engine.....	4-7
4.4.2.	CHECKLIST: Start diesel engine in cold environment.....	4-9
4.4.3.	Instruments: Turn the truck on ignition .....	4-9
4.4.4.	Instruments: After starting the diesel engine .....	4-10
4.4.5.	Instruments: During driving.....	4-11
4.5.	Switching gears .....	4-12
4.5.1.	Gear lever.....	4-13
4.5.2.	Rotary switch.....	4-14
4.5.3.	Automatic mode .....	4-15
4.5.4.	Manual mode.....	4-16
4.6.	Driving off .....	4-17
4.7.	Driving backwards .....	4-18

4.8. Brakes .....	4-19
4.8.1. Service brake .....	4-19
4.8.1.1. Service brake at trailer connection .....	4-19
4.8.2. Parking brake .....	4-20
4.8.2.1. Parking brake at trailer connection .....	4-21
4.8.2.2. Parking brake as an emergency brake .....	4-21
4.8.3. Engine brake .....	4-22
4.8.4. Retarder .....	4-23
4.8.5. Bremsomat .....	4-24
4.9. Stop .....	4-25
4.9.1. Turn off diesel engine .....	4-25
4.9.2. Parking .....	4-25
4.9.3. Long-term parking / garaging .....	4-26
4.10. Speed regulators .....	4-27
4.10.1. Cruise control .....	4-27
4.10.2. Variable speed limitation device .....	4-28
4.10.3. Engine speed control (ESC) .....	4-30
4.11. Uphill and downhill driving .....	4-31
4.12. Refuelling .....	4-32
4.12.1. Refuelling diesel .....	4-32
4.12.2. Refuelling AdBlue .....	4-33
4.13. Off-the-road driving .....	4-35
4.13.1. Axle load .....	4-35
4.13.2. Axle height adjustment .....	4-36
4.13.2.1. Axle blocking .....	4-37
4.13.2.2. Off-the-road mode .....	4-38
4.13.2.3. Levelling .....	4-39
4.13.3. Off-the-road gear .....	4-39
4.13.4. Differentials .....	4-40
4.13.4.1. Longitudinal differential lock .....	4-41
4.13.4.2. Transversal differential lock .....	4-41
4.13.5. Manoeuvring: Steering system .....	4-42
4.13.5.1. Steering program: Small turning cycle .....	4-45
4.13.5.2. Steering program: Manual .....	4-46
4.13.5.3. Steering program: Crab steering .....	4-47
4.13.5.4. Steering program: Wall steering .....	4-48
4.13.6. Manoeuvring: gear box .....	4-49
4.14. Driving with a trailer .....	4-49
4.14.1. Coupling of the trailer .....	4-51
4.14.2. Uncoupling of the trailer .....	4-51
4.15. Buffer beam .....	4-51
4.15.1. Folding the buffer beam .....	4-52
4.15.2. Unfolding the buffer beam .....	4-53
4.16. Driving with an erected tower .....	4-54
4.16.1. Conditions for driving with an erected tower .....	4-55
4.16.2. Instructions for driving with an erected tower .....	4-57
4.17. Towing .....	4-59
4.17.1. Towing with functioning diesel engine, service brake and steering system .....	4-60
4.17.2. Towing with a malfunctioning diesel engine .....	4-61
4.17.2.1. Service brake when towing with malfunctioning diesel engine .....	4-62
4.17.2.2. Releasing the parking brake when towing with malfunctioning diesel engine .....	4-63
4.17.3. Enabling transfer case to neutral position .....	4-64
4.17.3.1. Remove drive shafts on output shafts of the transfer case .....	4-64
4.17.3.2. Power-assisted steering .....	4-64
4.17.4. Towing with damage to the transfer case .....	4-65
4.17.5. Towing with damage to the driven axles .....	4-65

5.	Maintenance truck.....	5-1
5.1.	When is the right time to thoroughly inspect your Spierings crane? .....	5-1
5.1.1.	Electronic component.....	5-1
5.1.2.	Drive component of the crane .....	5-1
5.1.3.	Jib sections and towers .....	5-2
5.1.4.	Ty bars, A-frames, erecting cylinder and luffing cylinders .....	5-2
5.1.5.	Lift.....	5-2
5.1.6.	Outrigger system .....	5-2
5.2.	Maintenance truck after commissioning.....	5-3
5.2.1.	First service truck .....	5-3
5.3.	Maintenance schedule truck.....	5-4
5.3.1.	Maintenance schedule diesel engine truck.....	5-5
5.3.2.	Maintenance schedule drive line .....	5-6
5.3.3.	Maintenance schedule steering system.....	5-6
5.3.4.	Maintenance schedule electrical system truck .....	5-6
5.3.5.	Maintenance schedule lighting truck.....	5-7
5.3.6.	Maintenance schedule hydraulic system truck .....	5-7
5.3.7.	Maintenance schedule pneumatic system.....	5-7
5.3.8.	Maintenance schedule lubrication truck.....	5-8
5.3.9.	Maintenance schedule others truck.....	5-8
6.	Electrical system .....	6-1
6.1.	Alternator .....	6-1
6.2.	Batteries .....	6-2
6.2.1.	Checking batteries.....	6-2
6.2.2.	Charging batteries .....	6-3
6.2.3.	Replacing batteries.....	6-3
6.3.	Main switch.....	6-4
6.4.	Fuses.....	6-5
6.4.1.	Fuses in the fuse box .....	6-5
6.4.2.	Main fuses .....	6-5
6.4.3.	Fuses in the control cabinet of the truck .....	6-6
7.	Lighting .....	7-1
7.1.	Low beam .....	7-2
7.2.	Main beam.....	7-3
7.3.	Parking light.....	7-3
7.4.	Direction indicator .....	7-4
7.4.1.	Front direction indicator.....	7-4
7.4.2.	Side direction indicator .....	7-5
7.4.3.	Rear direction indicator.....	7-5
7.4.4.	Direction indicators buffer beam .....	7-6
7.5.	Tail light .....	7-6
7.5.1.	Tail light truck .....	7-6
7.5.2.	Extra tail light on the tower .....	7-7
7.5.3.	Tail light buffer beam.....	7-7
7.6.	Brake light.....	7-7
7.6.1.	Brake light truck.....	7-7
7.6.2.	Extra brake light on the tower.....	7-7
7.6.3.	Brake light buffer beam .....	7-8
7.7.	Reverse drive light.....	7-8
7.7.1.	Reverse drive light truck.....	7-8
7.7.2.	Reverse dive light buffer beam.....	7-8
7.8.	Fog tail light .....	7-8
7.8.1.	Fog tail light truck .....	7-8
7.8.2.	Fog tail light buffer beam.....	7-8

7.9.	Side marking lights .....	7-9
7.9.1.	Side marking light truck .....	7-9
7.9.2.	Side marking light buffer beam .....	7-10
7.10.	Contour lights .....	7-10
7.10.1.	Front contour lights .....	7-10
7.10.2.	Rear contour light .....	7-11
7.11.	License plate lights .....	7-12
7.12.	Rotaflores .....	7-13
7.13.	Work lamps .....	7-14
8.	Hydraulic system .....	8-1
8.1.	Hydraulic tank .....	8-1
8.1.1.	Checking oil level .....	8-2
8.1.2.	Topping up oil .....	8-2
8.1.3.	Analysing oil .....	8-2
8.1.4.	Refreshing oil .....	8-3
8.2.	Hydraulic pumps .....	8-3
8.3.	Filters .....	8-3
8.3.1.	Replacing the hydraulic fine filter .....	8-4
8.3.2.	Replacing the hydraulic coarse filter .....	8-5
8.3.3.	Replacing the hydraulic fine filter at rear axle steering .....	8-6
9.	Pneumatic system .....	9-1
9.1.	Primary system: the brakes .....	9-1
9.2.	Secondary system .....	9-2
9.3.	Air dryer .....	9-3
9.3.1.	Replacing filter air dryer .....	9-3
9.4.	Compressed air reservoirs .....	9-4
9.5.	Oil atomizer / water separator .....	9-4
9.5.1.	Topping up oil atomizer .....	9-5
9.5.2.	Performance water separator .....	9-5
9.5.3.	Replacing element water separator .....	9-5
9.5.4.	Adjusting air pressure secondary air circuit .....	9-5
9.6.	Checking brake pressure .....	9-6
9.6.1.	Pressure brake boosters .....	9-6
9.7.	Hoses and connections pneumatic system .....	9-6
10.	Diesel engine truck .....	10-1
10.1.	Specifications diesel engine truck .....	10-1
10.2.	Engine oil diesel engine truck .....	10-2
10.2.1.	Checking oil level diesel engine truck .....	10-2
10.2.1.1.	Checking oil level on the main screen .....	10-3
10.2.1.2.	Checking oil level by means of a dipstick .....	10-3
10.2.2.	Topping up oil diesel engine truck .....	10-4
10.2.3.	Refreshing oil diesel engine truck .....	10-5
10.2.3.1.	Draining oil .....	10-5
10.2.3.2.	Replacing oil filter element .....	10-6
10.2.3.3.	Topping up oil .....	10-6



10.3. Cooling system diesel engine truck .....	10-7
10.3.1. Checking coolant level diesel engine truck.....	10-7
10.3.2. Topping up coolant diesel engine truck.....	10-8
10.3.3. Refreshing coolant diesel engine truck.....	10-9
10.3.4. Anti-freeze concentration.....	10-10
10.3.5. Cleaning radiator diesel engine truck .....	10-10
10.3.5.1. Cleaning the radiator with compressed air.....	10-10
10.3.5.2. Cleaning the radiator with water .....	10-11
10.3.6. Air intake system diesel engine truck .....	10-11
10.3.7. Cleaning air filter diesel engine truck.....	10-12
10.3.8. Replacing air filter element diesel engine truck .....	10-13
10.4. Fuel system diesel engine truck .....	10-13
10.4.1. Checking fuel system .....	10-14
10.4.2. Fuel tanks.....	10-15
10.4.3. Fuel pre-filter / water separator .....	10-15
10.4.3.1. Draining water separator .....	10-16
10.4.3.2. Replacing fuel pre-filter / water separator.....	10-16
10.4.4. Fuel filter diesel engine truck.....	10-17
10.4.5. Venting fuel system diesel engine truck .....	10-19
10.4.6. Fuel transfer pump .....	10-20
10.5. EAS system .....	10-21
10.5.1. AdBlue filter .....	10-21
10.5.2. Air filter / oil separator EAS-system.....	10-22
10.6. Drive belts diesel engine truck.....	10-23
10.6.1. Poly-V-belt.....	10-23
10.6.2. Poly-V-belt of the alternator.....	10-26
11. Drive line.....	11-1
11.1. Gear box.....	11-1
11.1.1. Specifications gear box .....	11-1
11.2. General maintenance gear box .....	11-1
11.2.1. Checking oil level gear box.....	11-2
11.2.2. Refreshing oil gear box.....	11-3
11.2.3. Replacing oil filter retarder.....	11-4
11.3. Transfer case.....	11-6
11.3.1. General maintenance transfer case.....	11-6
11.3.2. Checking oil level transfer case .....	11-7
11.3.3. Refreshing oil transfer case.....	11-8
11.4. Axles.....	11-8
11.4.1. Axle configuration .....	11-9
11.4.2. Checking oil level differentials .....	11-9
11.4.3. Refresh oil differential.....	11-10
11.4.4. Checking oil level axle hubs .....	11-11
11.4.5. Refreshing oil axle hubs .....	11-12
11.5. Tyres.....	11-13
11.5.1. General maintenance .....	11-13
11.5.2. Tyre pressure .....	11-13
11.6. Brake linings .....	11-14
11.6.1. Checking brake linings .....	11-14

12.	Steering system .....	12-1
12.1.	Steering modes.....	12-1
12.1.1.	On-the-road mode .....	12-2
12.1.2.	Off-the-road mode .....	12-2
12.2.	Steering mechanisms .....	12-2
12.3.	Performance steering system .....	12-3
12.3.1.	Steering circuits.....	12-4
12.3.1.1.	Steering circuit 1 .....	12-4
12.3.1.2.	Steering circuit 2.....	12-4
12.3.1.3.	Rear axle steering .....	12-5
12.4.	Maintenance steering system .....	12-5
12.4.1.	Checking steering system .....	12-5
12.4.2.	Aligning.....	12-5
13.	Lubrication .....	13-1
13.1.	Automatic lubrication system truck .....	13-1
13.1.1.	Grease pump.....	13-1
13.1.2.	Timer .....	13-2
13.1.3.	Lubrication points central lubrication system .....	13-3
13.2.	Manual lubrication truck.....	13-4
13.2.1.	Retractable cylinders outrigger beams .....	13-4
13.2.2.	Drive shafts .....	13-4
13.2.3.	Steering system.....	13-5
13.2.4.	Tower support .....	13-5
14.	Specifications truck .....	14-1
14.1.	Maintenance specifications diesel engine truck.....	14-1
14.2.	Specifications drive line .....	14-2
14.2.1.	Specifications gear box .....	14-2
14.2.2.	Specifications transfer case.....	14-2
14.2.3.	Specifications axles / brakes / tyres .....	14-2
14.3.	Specifications electric system truck .....	14-3
14.4.	Specifications hydraulic system truck .....	14-3
14.5.	Specifications pneumatic system truck.....	14-3
14.6.	Specifications lubricants truck .....	14-3
15.	Annexes .....	15-1

## 1. General data

The AT5 carriage is especially designed for the Spierings SK599 folding crane. Extra attention is paid to a safe and comfortable transport to the work site. The crane is suited for driving on public roads, fully equipped with counterweight and tools. The chassis is a specially rigid structure to create a good crane support.

Picture 1-1 shows the measurements of the SK599 with the AT5-carriage. The measurements given are the overall dimensions, axle bases and turning circle (see also picture in the Annexes).

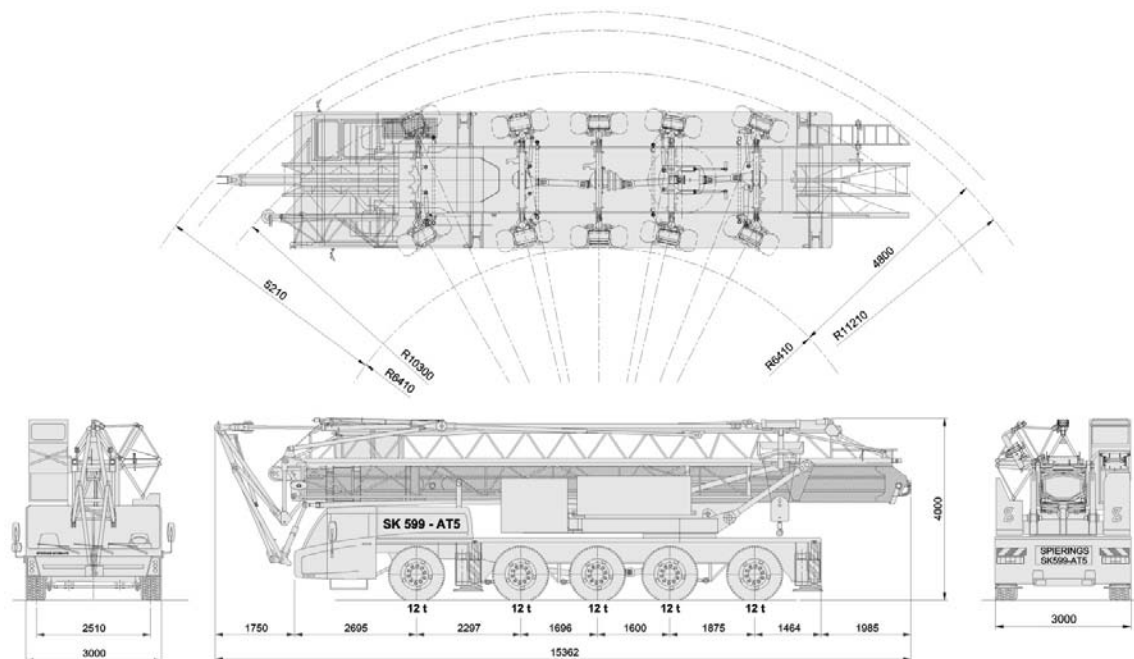

Picture 1-1

### 1.1. Dimensions and weight

- Length: 15.43 m;
- Width: 3.00 m;
- Height: 4.00 m;
- Mass: approx. 60,000 kg (complete vehicle);
- Axle load: approx. 12,000 kg.

### 1.2. Drive line

- 12.9 litre DAF diesel engine with turbo compressor and intercooler (MX375);
- ZF AS-Tronic automatic transmission with retarder, 16 forward gears and 2 reverse gears;
- ZF transfer case (VG2001/396) with high speed (road) and low speed (off the road) transmission;
- Electronic accelerator;
- 5x Kessler & Co axles, of which axles 2, 3 and 5 are driven;
- Maximum speed limited at 83 kph (52 mph);
- Minimum speed at 1,000 rpm diesel engine 1.4 kph (0.87 mph) (23.3 m/min).

### 1.3. Steering

- Axles 1 and 2 are mechanically steered with the steering wheel; axle 3 remains rigid, axles 4 and 5 are hydraulically steered;
- The steering system is hydraulically powered by means of a steering gear housing and auxiliary cylinders;
- The steering system is fitted with an emergency steering pump, so in case of main control pump malfunction or diesel break-down, the truck remains steerable until it stands still.

With regards to the steering, there is a difference between road and off the road steering.

For more information, see § 3.9.5. *Control panel steering system* and Chapter 12. *Steering system*.

#### 1.3.1. Road steering

Axles 1 and 2 are mechanically steered with the steering wheel; axle 3 remains rigid, axles 4 and 5 are hydraulically steered and steers speed-dependent in opposite direction till 50 kph (31 mph).

#### 1.3.2. Off-the-road steering

There are special steering programs which are only available in off-the-road mode:

(see § 4.13.5. *Manoeuvring: Steering system*):

- *Small turning circle*: this steering program enables an extra small turning circle;
- *Manual*: the steering movement of axles 4 and 5 can be controlled; axles 1 and 2 remain mechanically steered by the steering wheel; axle 3 is retracted;
- *Crab steering*: all steered axles steer in the same direction; axle 3 is retracted;
- *Wall steering*: this steering program enables to drive away from an object with minimum swing of the truck's rear; axle 3 is retracted.

Provisions for driving off the road:

- Adjustable axle height;
- Transfer case with off-the-road gear;
- Longitudinal and transverse differentials can be locked.

### 1.4. Suspension

- Hydro-pneumatic suspension;
- Possibility to block the suspension (e.g. when driving with erected tower).

### 1.5. Braking system

- Pneumatically operated brakes;
- Parking brake;
- Retarder;
- Optional: connection air braked trailer.

### 1.6. 4-Point outrigger system

- Full outrigger support base (wide): 7.50 m x 7.66 m;
- Reduced outrigger support base (narrow): 7.50 m x 5.72 m.

## Identification

Vehicle identification number (VIN):

- On the identification plate in the co-driver's leg room (on the left-hand side of the door) (*Picture 1-2, left*);
- Stamped in the right-hand frame girder in front of the first axle (*Picture 1-2, right*).

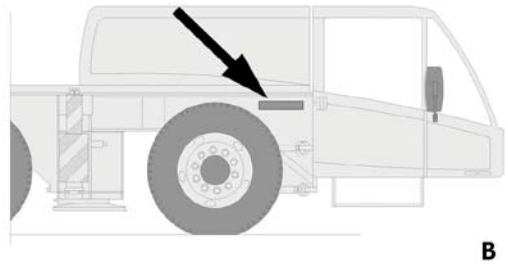

Picture 1-2

In case there is help needed from *ITS* (International Truck Service of DAF Trucks N.V.), the chassis number will be asked.

However, for Spierings cranes it is not the chassis number that is needed. ITS needs the engine number, which is listed on the UPEC chart and can be found underneath the cover plate of the central console in the truck cabin.

*International Truck Service*

Phone number in Europe +31 40 214 30 00



## 2. Introduction to the truck

### 2.1. Get to know the truck

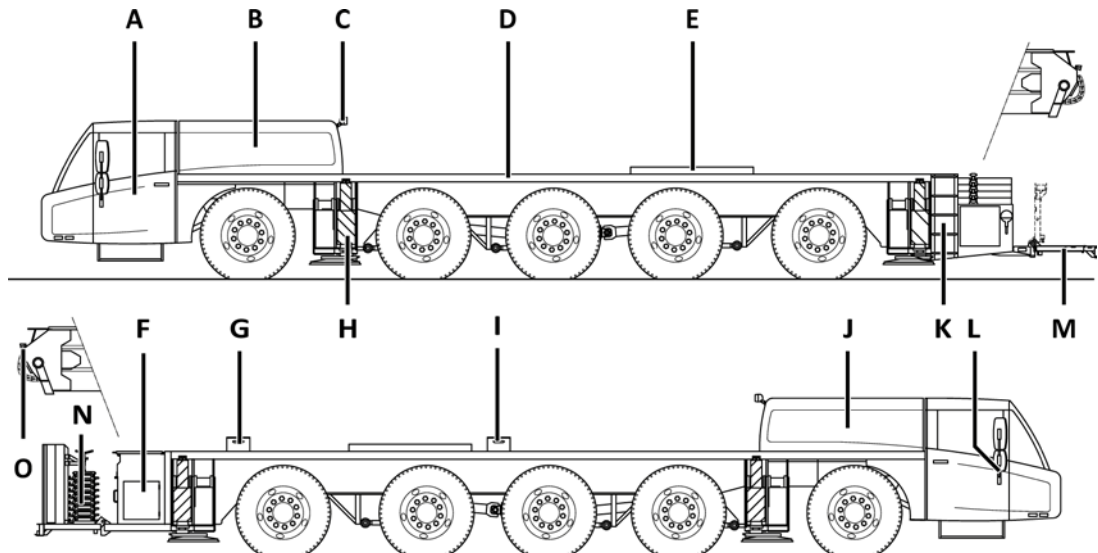

Picture 2-1

- A. Truck cab (see § 2.3. *Truck cab*);
- B. Left-hand engine cowling (see § 2.4.1. *Left-hand engine cowling*);
- C. Work lamps (see § 2.6. *Work lamps*);
- D. Crane platform;
- E. Superstructure slewing rim;
- F. Rear toolbox (optional) (see § 2.8. *Rear toolbox*);
- G. Filler neck fuel tank (see § 2.5. *Outriggers*);
- H. Outriggers (see § 2.5. *Outriggers*);
- I. Filler neck AdBlue tank;
- J. Right-hand engine cowling (see § 2.4.2. *Right-hand engine cowling*);
- K. Truck ladder (see § 2.9. *Truck ladder*);
- L. Side view camera (optional) (see § 2.11. *Side view camera (optional)*);
- M. Buffer beam;
- N. Storage box steel support partitions (see § 2.7. *Storage box*);
- O. Reverse drive camera (see § 2.10. *Reverse drive camera*).

## 2.2. Keys

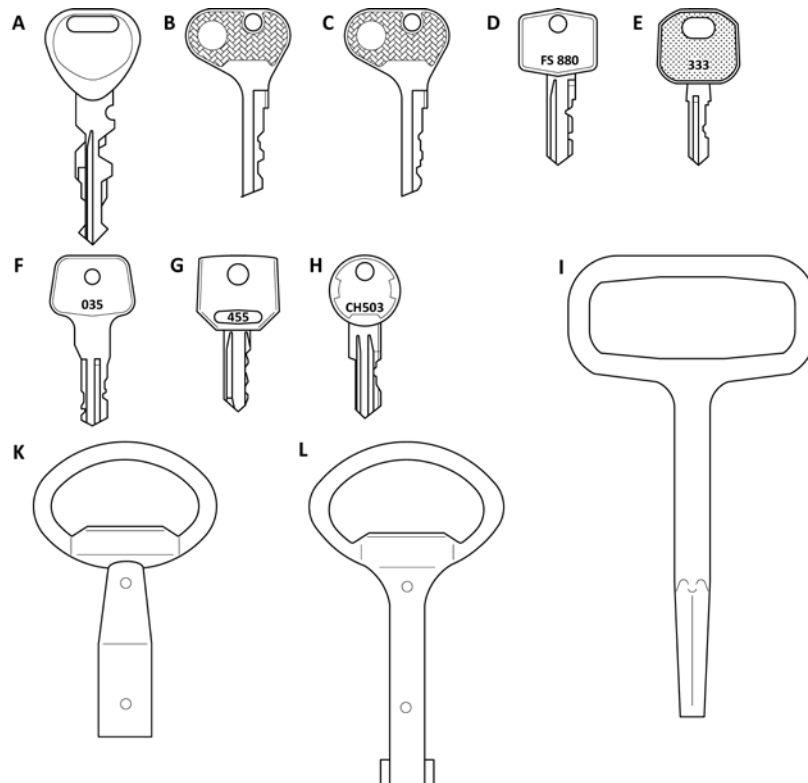

Picture 2-2

- A. Door key;
- B. Ignition key truck;
- C. Ignition key crane;
- D. Key hatch crane cab;
- E. General key:
  - Storage boxes truck;
  - Electrical cabinet;
  - Control panel control cabinet;
- F. Key fuel tank;
- G. Key operated selector switch:
  - Key operated selector switch full / reduced outrigger base;
  - Key operated selector switch emergency control lift on / off;
  - Key operated selector switch emergency control lift up / down;
- H. Key engine cowling truck:
  - Left-hand and right-hand cover of engine cowling truck;
- I. Cross key:
  - (Sliding) doors rear toolbox;
  - Removable cover plates engine cowling;
- K. Cross key engine cowling crane:
  - Doors engine cowling crane;
- L. Cross key control cabinet truck:
  - Control cabinet truck (for the benefit of suspension system and outrigger base).



## 2.3. Truck cab

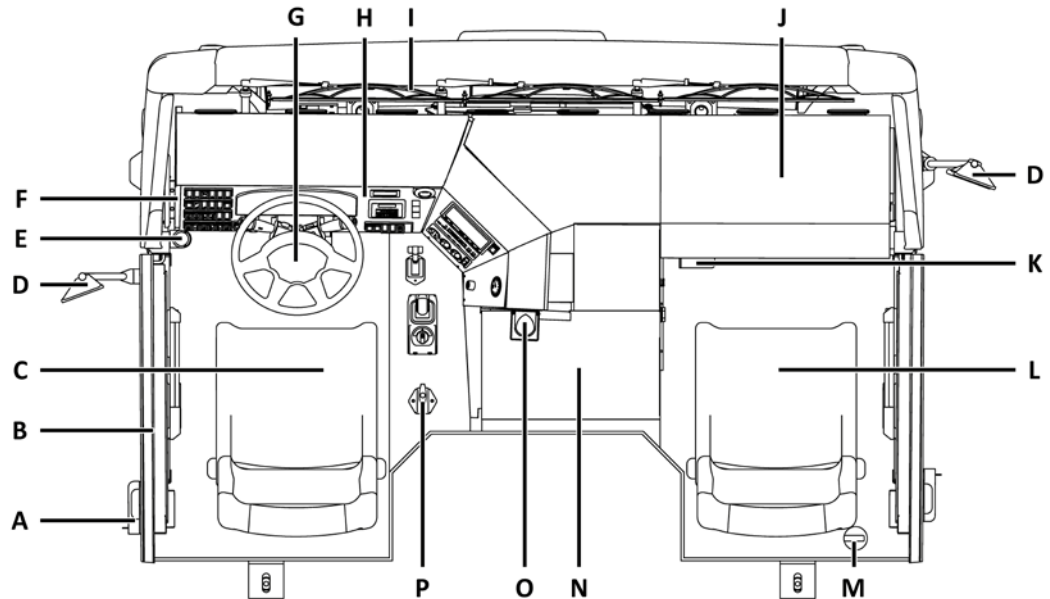

Picture 2-3

- A. Door handle with lock;
- B. Door;
- C. Driver's seat (see § 3.2. Seats);
- D. Wing mirrors (see § 3.3. Wing mirrors);
- E. Spirit level;
- F. Battery charger remote control batteries (see § 3.6. Battery chargers remote control batteries);
- G. Steering wheel;
- H. Control panel (see § 3.9. Control panel);
- I. Windscreen wipers (see § 3.9. Control panel, 42. Control lever left);
- J. Fuse box (see § 2.3.1. Fuse box);
- K. Windscreen washer reservoir (see § 3.7. Windscreen washer reservoir);
- L. Co-driver's seat (see § 3.2. Seats);
- M. Fire extinguisher (see § 3.8. Fire extinguisher);
- N. Central console (see § 2.3.2. Central console);
- O. Cup holder;
- P. Main switch truck (see § 3.9. Control panel, 56. Main switch truck).

### 2.3.1. Fuse box

The fuse box is located at the co-driver's side of the truck cab under the cover of the *dashboard*.

#### Open fuse box

1. Remove the two turning knobs at the front of the cover;
2. Open the cover; the cover can be fixed by means of *support A* (Picture 2-4).

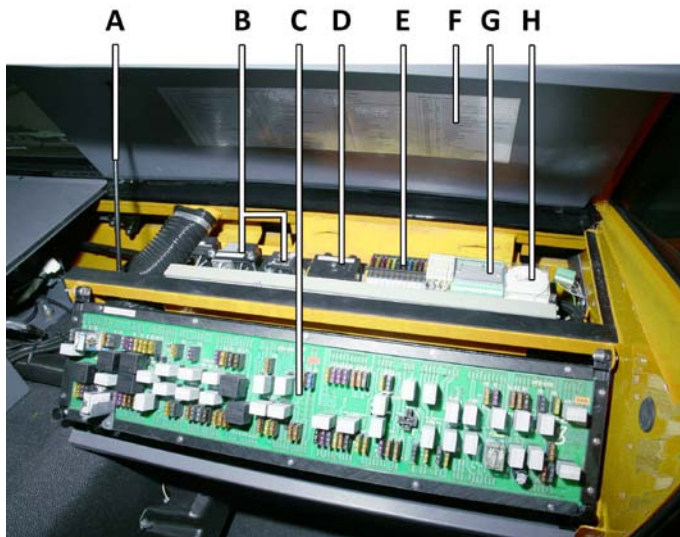

Picture 2-4

Under the cover, the following components can be found:

- A. Support;
- B. *Wake-up* relay;
- C. Circuit board with fuses and relays;
- D. Main fuses (2x 40 A);
- E. Fuses;
- F. Overview fuses;
- G. Standstill detector;
- H. Clock switch automatic lubrication system truck.

### 2.3.2. Central console

The central console (*Picture 2-5* and *Picture 2-6*) is situated between the driver's seat and the co- driver's seat.

#### Central console at driver's side



**A**

*Picture 2-5*

- A. Diagnostic connector OBD (On Board Diagnostics) for diagnosis of the full drive line (*Picture 2-5*) consists of:
- Diesel engine truck;
  - Gear box;
  - Retarder;
  - Dashboard.

### Central console at co-driver's side

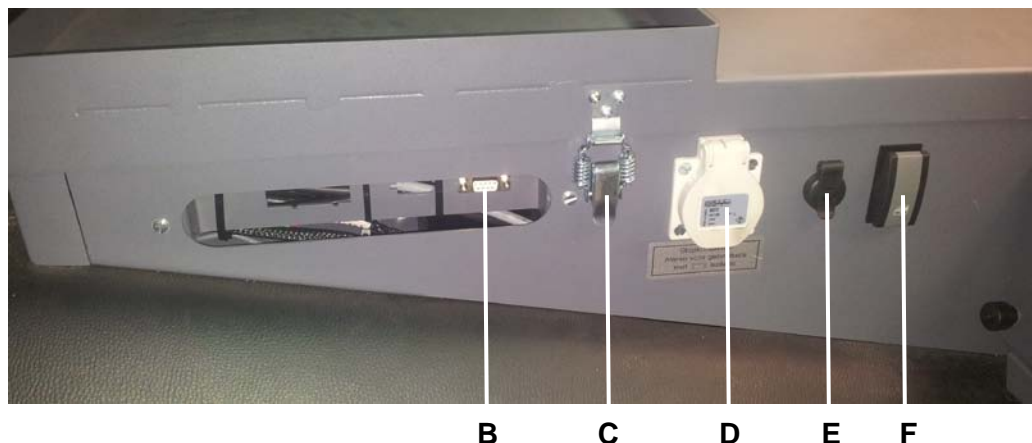

Picture 2-6

The central console at the co-driver's side consists of (*Picture 2-6*):

- B. Diagnostic connector steering system;
- C. Closing bracket;
- D. Power socket 230 V (voltage only at running crane generator);
- E. 12 V connector;
- F. Switch electrically operated window at co-driver's side.

### Remove cover central console

1. Open the *closing bracket C* at the co-driver's side (see *Picture 2-6*);
2. Take the cover at the front and tilt it upwards over the hinge pins;
3. Slide the cover horizontally from the hinge pins, in the direction of the co-driver's side.

**Contents central console**

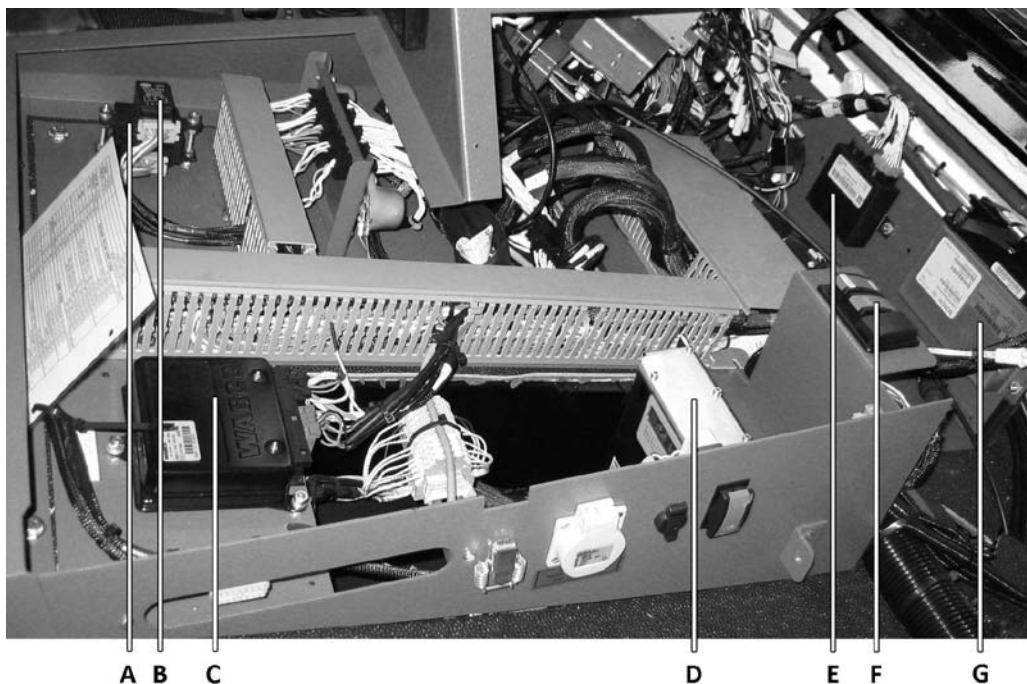

*Picture 2-7*

- A. Relay windscreen wipers;
- B. Relays indicators;
- C. ABS module;
- D. Control module steering system;
- E. Control module gear box;
- F. Switches transfer case neutral and ABS-reset;
- G. Control module retarder.

### 2.3.3. Tachograph



The tachograph is located on the driver's side on the central console. If a red triangle appears on the odometer on the dashboard (see *Picture 2-8*), it means that an error in the tachograph has occurred. This error message usually disappears as the tachograph is reset.



Picture 2-8

#### Reset tachograph

1. Remove the upper tachograph disc from the holder (if a disc is present) (*Picture 2-9*);
2. Open the holder from the upper tachograph disc and also remove the lower tachograph disc;
3. Then close the tray (the tachograph will automatically be reset);
4. Insert the lower and the upper tachograph disc again.

Now the red triangle on the odometer on the dashboard is mostly gone.

Please contact Spierings Mobile Cranes, if the red triangle remains lit.



Picture 2-9

## 2.4. Engine cowling

The engine compartment is located at the rear of the truck cab. It can be reached by removing two covers and four removable cover plates (*Picture 2-10*).



The covers are lockable at the handle.

Use key *engine cowling truck*.



The removable cover plates may be loosened or tightened by using cross key *engine cowling truck*.

The engine compartment is divided into three sections (1 to 3):

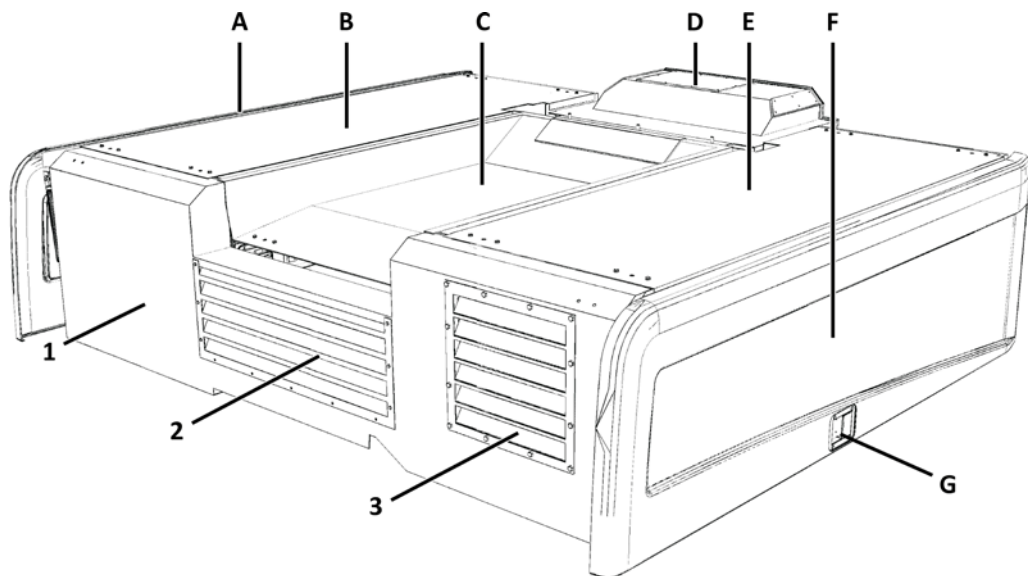

*Picture 2-10*

- A. Left-hand cover;
- B. Left-hand cover plate;
- C. Central cover plate;
- D. Cover plate truck cab;
- E. Right-hand cover plate;
- F. Right-hand cover;
- G. Handle with lock;

- 1. Left -hand engine cowling (see § 2.4.1. *Left-hand engine cowling*);
- 2. Central engine cowling;
- 3. Right-hand engine cowling (see § 2.4.2. *Right-hand engine cowling*).

### **ENTRAPMENT HAZARD!**

The left-hand and right-hand cover are both equipped with two gas springs, so the cover will remain open.



When closing, the cover may be slammed during the last part of the movement. Therefore, be careful when closing the cover that no parts of the body are trapped.

### 2.4.1. Left-hand engine cowling

At the left-hand engine cowling (*Picture 2-11*) the following parts can be found:

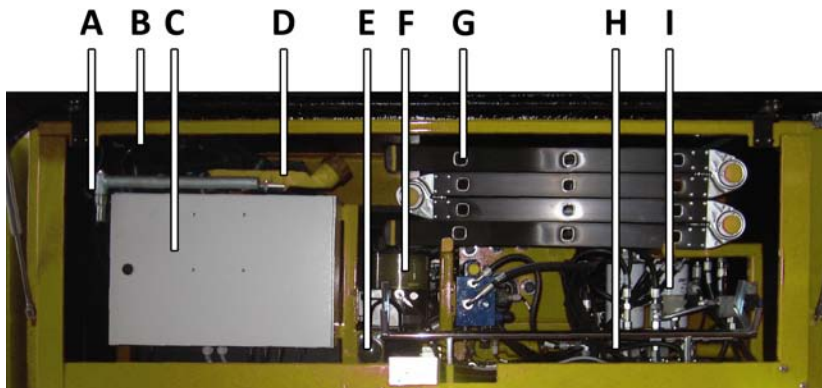

*Picture 2-11*

- A. Dipstick engine oil;
- B. Coolant reservoir;
- C. Control cabinet (for the benefit of the suspension and outrigger system);
- D. Filler neck engine oil;
- E. NATO-connector;
- F. Grease pot automatic lubrication system truck;
- G. Ladder;
- H. Hydraulic coarse filter;
- I. Hydraulic blocks suspension system .

### 2.4.2. Right-hand engine cowling

At the right-hand engine cowling (*Picture 2-12*) the following components are present:

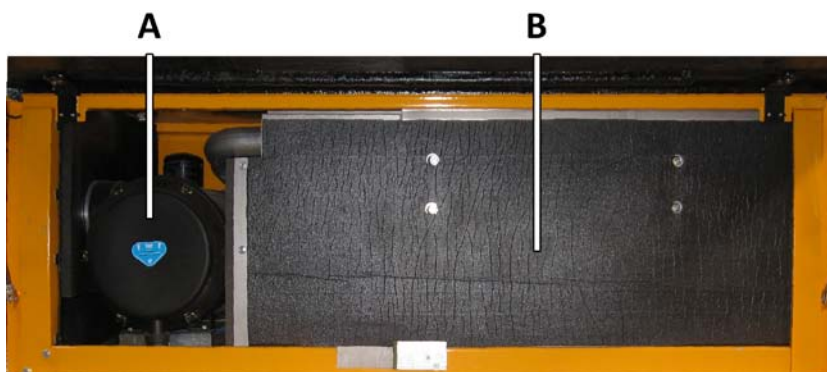

*Picture 2-12*

- A. Air filter diesel engine;
- B. Noise reduction wall:
  - Behind this noise reduction wall, the combined intercooler/radiator/oil cooler with a double hydraulic driven fan are found.



## 2.5. Outriggers

At both sides of the truck there are two extending *outrigger beams A* each (Picture 2-13), and to each beam a hydraulically operated *outrigger D*. These outriggers keep the machine stable during hoisting operations.

The outrigger beams have an *antiskid coating B* to prevent slipping.

The *outrigger pad holders E* can be used as support to step on the outrigger beam.

In transport mode, the *outrigger plate F* must be pushed over *outrigger plate guide H*.

The outriggers can be operated from the truck cab or by using the remote outrigger control.

For more information, see *Crane manual, Chapter 5. Crane set-up*.

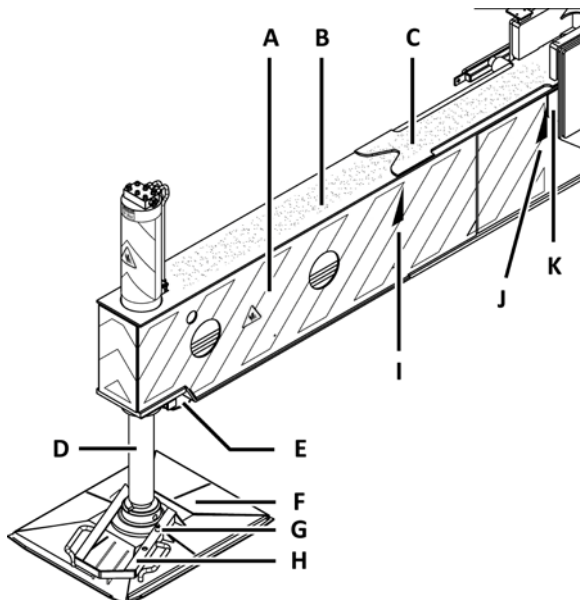

Picture 2-13

- A. Outrigger beam;
- B. Antiskid coating;
- C. Reinforcement plate;
- D. Outrigger (-cylinder);
- E. Transport support;
- F. Outrigger plate;
- G. Locking pin;
- H. Outrigger plate guide;
- I. Tag triangle reduced outrigger support base;
- J. Tag triangle full outrigger support base;
- K. End outrigger beam chassis.

Both outrigger beams at the rear of the truck are equipped with a spirit level.

## 2.6. Work lamps

At the rear of the engine cowling and at the rear of the truck, there are two work lamps mounted at each side (left and right). There are also work lamps mounted at the outrigger beams (see § 7.13. *Work lamps*).



These work lamps can be operated from the truck cab (see § 3.9. *Control panel*).

The work lamps at the rear of the engine cowling can be horizontally adjusted (*Picture 2-14, point 2*).

Follow the next steps for adjusting the work lamps properly:

- Turn the *knob A* on the bracket counterclockwise (see *Picture 2-14*);
- After adjusting, fix the work lamp by turning the knob clockwise.

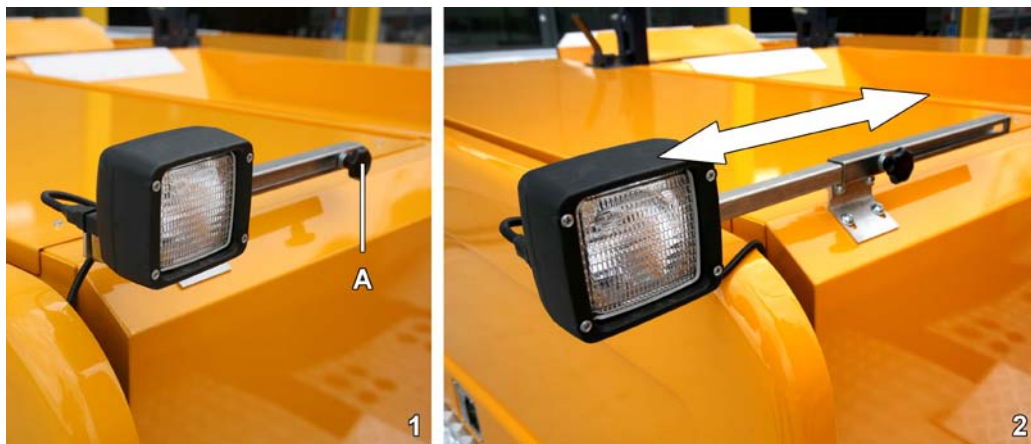

Picture 2-14

### CAUTION!



The work lamps at the rear of the engine cowling must be fully retracted before driving the vehicle on public roads.

## 2.7. Storage box

The steel support partitions are situated at the backside of the vehicle. Using an optional auxiliary crane on the tower, these steel support partitions can be placed. Use those steel support partitions in order to have a stabilized construction at a softer soil.

For more information see *Crane manual Chapter 5. Crane set-up*.

## 2.8. Rear toolbox

The optional rear toolbox is a specially made storage box at the back side of the truck. It can be opened by using the cross key. The toolbox consists of two doors (at left and right side of the truck) and a sliding door in the middle at the back side of the truck.

## 2.9. Truck ladder

In order to climb safely on the crane platform, a ladder is mounted at both sides of the truck (when the optional auxiliary crane is chosen).

There is also an auxiliary ladder available in the engine cowling of the truck.

## 2.10. Reverse drive camera

For additional visibility at the rear of the truck, a reverse drive camera is mounted at the bottom of the tower. The image of the reverse drive camera is displayed on the monitor in the truck cab.

## 2.11. Side view camera (optional)

The image of the optional side view camera is displayed on a monitor in the truck cab.



### INFORMATION!

For more information, see *Chapter 4. Driving*.



## 3. Operating the truck

### 3.1. Doors

Open the door at the outside by grabbing the grip and pushing the thumb onto the locking.  
In order to open the door from the inside, the lever must be turned upwards.



The door can be locked from the outside by using the *door key*:

- Open: turn the *door key* in the direction of the front of the vehicle;
- Lock: turn the *door key* in the direction of the rear of the vehicle.

#### 3.1.1. Windows

The doors are provided with electrical operated windows.



Both door windows can be moved upwards/downwards by operating the switches *door window driver's side* and *door window co-driver's side* on the control panel (see § 3.9. *Control panel*).

Make sure the windows are clean before driving the truck.

#### 3.1.2. Ashtray

At the inner side of the door an ashtray is mounted. To empty the ashtray, press the lock downwards and remove the ashtray.

#### 3.1.3. Getting in

Use the step under the door to get in.

### 3.2. Seats

There are two seats mounted in the truck cab, one for the driver and one for the co-driver. Both seats are provided with an integrated seat belt (see *Picture 3-1*).

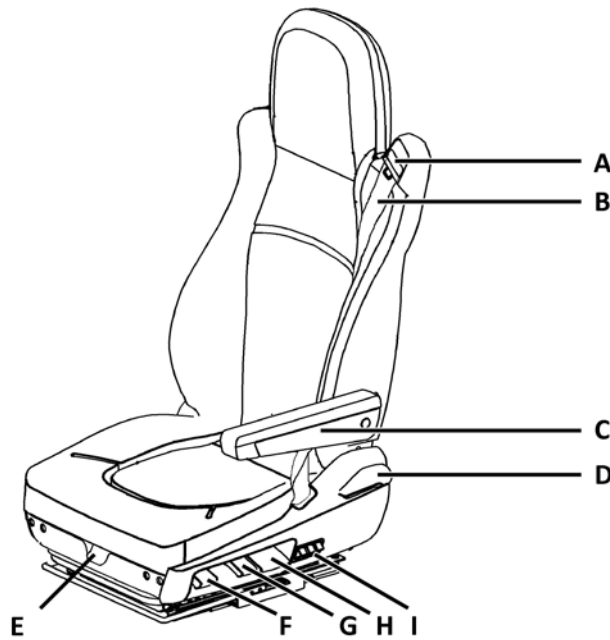

Picture 3-1

#### Driver's seat:

- A. Inertia reel seat belt;
- B. Seat belt (see § 3.2.2. *Seat belts*);
- D. Back adjustment;
- E. Chair seat adjustment;
- F. Transfer lift;
- G. Tilting the seat;
- H. Height adjustment;
- I. Lumbar support adjustment.

#### Co-driver's seat:

- A. Inertia reel seat belt;
- B. Seat belt (see § 3.2.2. *Seat belts*);
- C. Folding arm rest;
- D. Back adjustment.

#### CAUTION!



- The co-driver's seat is not suitable for installing a child's seat;
- The seats may only be repaired and mounted by qualified personnel.

### 3.2.1. Seat adjustments

**CAUTION!**

- The driver's seat may only be adjusted when the vehicle is not moving;
- All adjustments should only be carried out under load;
- The seat lock must audibly click into place;
- Always operate one control at a time.



The co-driver's seat has air suspension. If the seat is not occupied, it will go to its lowest position. If someone sits on the seat, the seat will move to its most recently set height. This only happens if there is sufficient air pressure present (approx. 7 bar). (If necessary, the diesel engine can be turned on to pressurize the air system.)

Explanation adjustments as shown in *Picture 3-1*:

**D. Back adjustment:**

- Press the switch;
- Determine the desired position by pushing the back of the seat;
- Release the switch;

**E. Seat adjustment:**

- Press the lever;
- Determine the desired position by pushing the seat;
- Release the lever;

**F. Transfer lift:**

- Lever downwards (when seat is in driving position): seat will go to its lowest position;
- Lever upwards (when seat is lowered): seat will go to the most recent set height;

**G. Tilting the seat:**

- Lever downwards: seat tilts downwards;
- Lever upwards: seat tilts upwards;

**H. Height adjustment:**

- Lever downwards: seat moves downwards;
- Lever upwards: seat moves upwards;

**I. Lumbar support adjustment:**

- Switch downwards: inflate lumbar support;
- Switch upwards: deflate lumbar support.



### 3.2.2. Seat belts

The driver and co-driver must wear the seat belts when driving.

**CAUTION!**



Only a tensioned seat belt functions well. Therefore never use a seat belt clip or something else to prevent the seat belt from tensioning.

**CAUTION!**



If the seat belt was heavy loaded during a collision, it must be completely replaced, even if it looks like there is nothing wrong with it.

**3.2.2.1. Fasten seat belt**

1. Grab the belt closure of the seat belt;
2. Move the seat belt from the inertia reel over the shoulder in the direction of the seat belt clip;
3. Click the metal belt closure into the seat belt clip.

**3.2.2.2. Loosen seat belt**

1. Press the red coloured *press* button and remove the belt closure from the seat belt clip;
2. Move the seat belt over de shoulder in the direction of the inertia reel:
  - Check if the inertia reel seat belt functions properly;
3. Release the seat belt.

**3.2.2.3. Check seat belts**

**CHECK / TEST!**



Timely check the state and operation of the seat belts.  
For maintenance intervals, see the maintenance schedule in § 5.2.9. *Maintenance schedule others truck.*

**CAUTION!**



Never make changes or repairs to the seat belts.  
Always replace the whole seat belt when the belt is worn or damaged.

- Check the seat belts for wear;
- Check its operation by jerking the belt from its winding mechanism:
  - The belt must be locked immediately. Have the lock repaired or replaced if it does not function properly.

**3.2.2.4. Cleaning seat belts**

Clean the seat belts with a regular cleaner.

**CAUTION!**



Never clean the seat belts with agressive cleaning agents!



### 3.3. Wing mirrors

The wing mirrors may be adjusted by hand.

Make sure the mirrors are adjusted before driving off, so an optimal view has been required.



The mirror heating can be switched on with a switch on the control panel (see § 3.9. Control panel, 10. Switch mirror heating).

### 3.4. Sun blinds

To prevent sunlight from blinding, a sun blind is mounted above the windscreen for both the driver and the co-driver.



Picture 3-2

#### Pull down

- Pull down the blind with the *joggle A* in the middle of the blind (Picture 3-2); the blind will remain in the desired position.

#### Roll up

- Pull down the black *strap B* on the side of the blind to roll it up (Picture 3-2).

### 3.5. Storage room

In the middle of the cab ceiling there is a storage compartment present (Picture 3-3), reachable from both the driver's and the co-driver's side.



Picture 3-3



The storage compartment has a lockable lid at both sides, which can be locked by using the *general key*.

### 3.6. Battery chargers remote control batteries

Every remote control comes with two batteries each.

The charging unit for the batteries of the remote controls is found at the left, under the dashboard at the driver's side.

**The batteries will always be charged**, even if the *main switch truck* is not enabled

(see § 3.9. *Control panel, 56. Main switch truck*):

- While the batteries are charged, the *indicator A* lights up (*Picture 3-4*);
- As soon as they are fully charged, the lamp starts flashing.

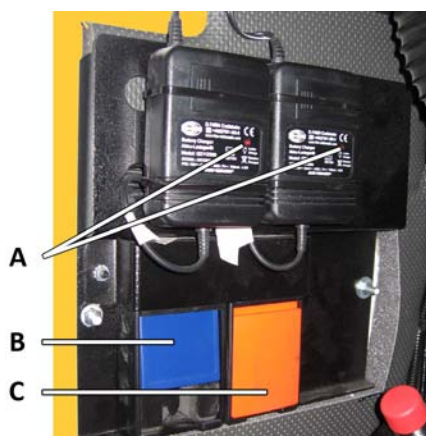

Picture 3-4

- A. Indicator;
- B. Battery charger remote control outriggers;
- C. Battery charger remote control crane.

### 3.7. Windscreen washer reservoir

**CHECK / TEST!**



Timely check the fluid level of the windscreen washer reservoir.  
For maintenance intervals see the maintenance schedule in  
§ 5.2.9. *Maintenance schedule others truck.*

The windscreen washer reservoir B is situated at the left of the co-driver's side (Picture 3-5).  
The reservoir may be filled through the screw cap at the top.



Picture 3-5

### 3.8. Fire extinguisher

**CHECK / TEST!**



The fire extinguishers must be regularly inspected by an approved body.  
For maintenance intervals see the maintenance schedule in  
§ 5.2.9. *Maintenance schedule others truck.*

The fire extinguisher is situated behind the co-driver's seat.  
At the right side behind the control box in the crane cab, there is a second fire extinguisher present.

### 3.9. Control panel

The control panel (*Picture 3-6*) is located on the dashboard and to the right side of the driver.

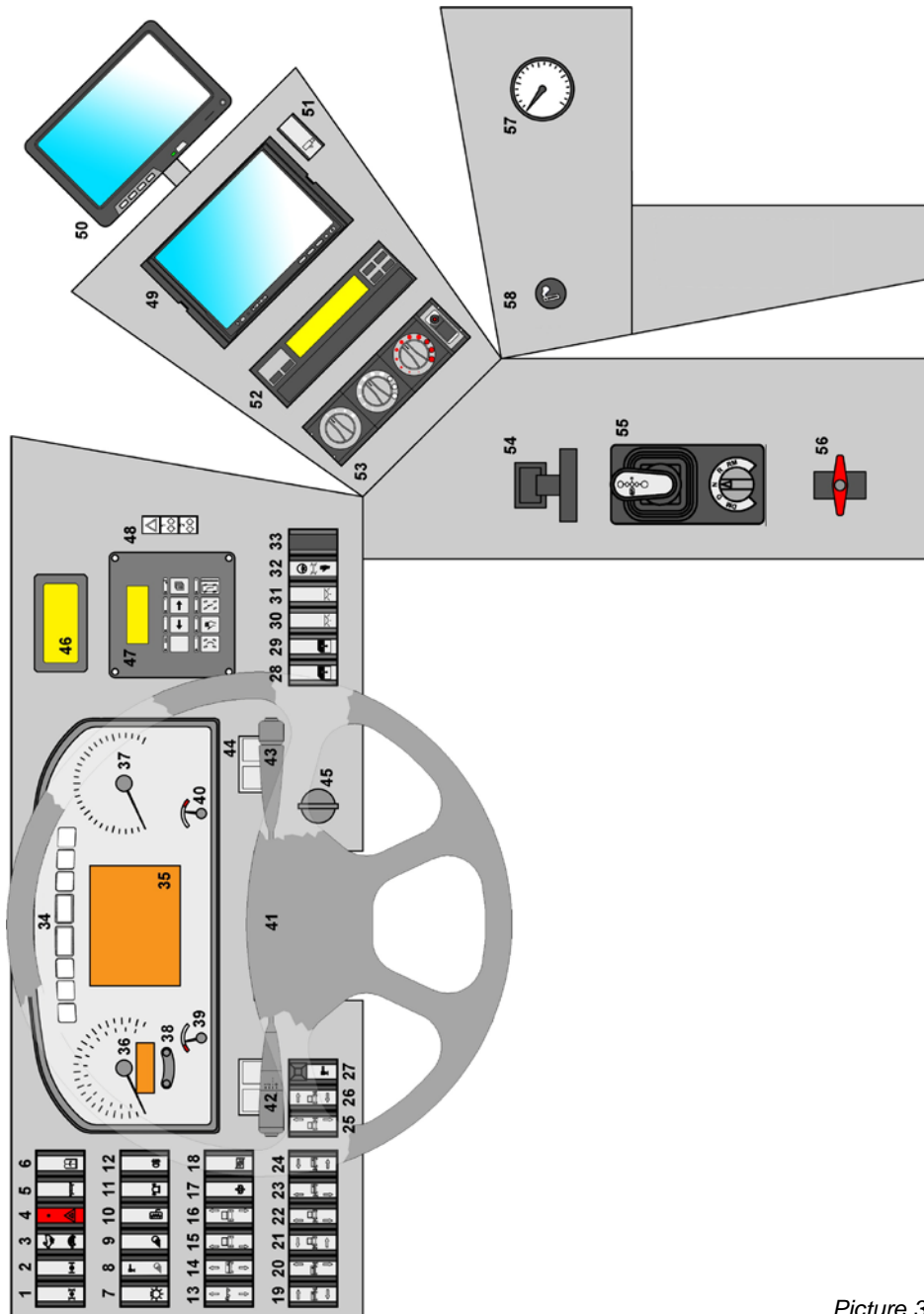

Picture 3-6

**CAUTION!**



The switches and control panels in this section are just briefly explained. For further explanation, procedures and safety regulations, see the related paragraph.

**CAUTION!**



Improper handling of the switches and control panels may lead to dangerous situations or damage.

	<p><b>1. Switch longitudinal differential lock</b></p> <p>Using this switch the function of the <i>longitudinal differential lock</i> may be switched on or off. Press the switch (on) when driving off the road and no traction is obtained (see § 4.13.4.1. <i>Longitudinal differential lock</i>).</p>
	<p><b>2. Switch transversal differential lock</b></p> <p>Using this switch the function of the <i>transversal differential lock</i> may be switched on or off. Press the switch when using longitudinal differential lock enables still not enough traction. By releasing the switch, it will go back to its original position and the transversal differential lock will be disabled (see § 4.13.4.2. <i>Transversal differential lock</i>).</p>
	<p><b>3. Switch transfer case high/low</b></p> <p>This switch enables the driver to switch to high or low gear.</p> <p>Switch to <i>road mode (high / hare)</i> when driving on public or paved roads.</p> <p>Switch to <i>off-the-road mode (low / turtle)</i> when driving off the road or difficult terrain (see § 12.1. <i>Steering modes</i>).</p>
	<p><b>4. Switch hazard warning lights</b></p> <p>In case of an emergency the hazard warning lights may be switched on and off (the indicators left and right at the vehicle, at the front and at the rear are flashing or were switched off) (see Table 3-3 and § 7.4. <i>Direction indicator</i>).</p>
	<p><b>5. Switch aeronautic warning lights</b></p> <p>When the work site is near an airport, the aeronautic warning lights must be switched on (<i>Crane manual</i>, § 5.1.6. <i>Objects and obstacles</i>).</p>
	<p><b>6. Main screen switch</b></p> <p>This switch allows the user to navigate through various pages on the main screen. (see § 3.9.2 <i>Main screen</i>).</p>

Table 3-1







	<p><b>7. Switch vehicle lights</b></p> <p>Using this switch, the vehicle lights are switched on or off.        (see § 4.3.2. CHECKLIST: Check vehicle lights).</p> <p>The switch has three positions:</p> <ul style="list-style-type: none"> <li>• Off;</li> <li>• Base lights on, consisting of:           <ul style="list-style-type: none"> <li>- Parking light;</li> <li>- Tail lights;</li> <li>- Side marking lights;</li> <li>- Contour lights;</li> <li>- License plate lights;</li> <li>- Control panel lighting.</li> </ul> </li> <li>• Base lights and low beam on.</li> </ul>
	<p><b>8. Switch work lamps at outrigger beam</b></p> <p>Using this switch, the <i>work lamps</i> above the outrigger beams are switched on or off        (see § 7.13. Work lamps).</p> <p>There is no indicator visible on the control panel.</p>
	<p><b>9. Switch work lamps at engine cowling</b></p> <p>Using this switch the <i>work lamps</i> at the rear of the engine cowling are switched on or off        (see § 7.13. Work lamps).</p>
	<p><b>10. Switch mirror heating</b></p> <p>Using this switch the <i>mirror heating</i> is switched on or off (see § 3.3. Wing mirrors).</p>
	<p><b>11. Switch rotaflares</b></p> <p>Using this switch the <i>rotaflares</i> are switched on or off.</p> <p>The optional <i>rotaflares</i> on the counterweight are switched on or off by using the control panel at the <i>control cabinet crane</i> (see § 7.12. Rotaflares).</p>
	<p><b>12. Switch fog tail light</b></p> <p>Using this switch the <i>fog tail light</i> is switched on or off.</p> <p>The <i>fog tail light</i> can only be switched on when the vehicle lights are switched on        (see § 7.8. Fog tail light).</p>
	<p><b>13. Switch all axles up / down</b></p> <p>Using this switch the suspension cylinders of all axles move in or out simultaneously        (see Crane manual § 5.2.2. Crane set-up).</p>

Table 3-1  
 (page 2 of 12)

© 2016 Spierings Mobile Cranes – All rights reserved.

Dec 2016 Changes and typographical errors reserved.



	<p><b>14. Switch axles 1 and 2 up / down</b></p> <p>Using this switch the suspension cylinders of the two front axles move in or out simultaneously (see § 4.13.2. Axle height adjustment).</p>
	<p><b>15. Switch axles left-hand rear up / down</b></p> <p>Using this switch the suspension cylinders on the left-hand rear move in or out simultaneously (see § 4.13.2. Axle height adjustment).</p>
	<p><b>16. Switch axles right-hand rear up / down</b></p> <p>Using this switch the suspension cylinders on the right-hand rear move in or out simultaneously (see § 4.13.2. Axle height adjustment).</p>
	<p><b>17. Switch levelling</b></p> <p>Using this switch the truck will be levelled automatically, the suspension cylinders are moved to the driving height (see § 4.13.2.3. Levelling).</p> <p>This feature applies when the axle height is disrupted by e.g. outriggering, terrain mode or prolonged standstill.</p>
	<p><b>18. Switch release axle height adjustment</b></p> <p>Using this switch the axle height adjustment will be released (see § 4.13.2. Axle height adjustment).</p> <p>When this switch is pressed, switches 13 to 16 can be operated.</p> <p><b>The spring load of the truck will not be switched off.</b></p>
	<p><b>19. Switch outrigger beam left-hand front in / out</b></p> <p>Using this switch the outrigger beam on the left-hand at the front moves in or out (see Crane manual § 5.2.2. Crane set-up).</p>

Table 3-1  
 (page 3 of 12)

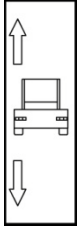
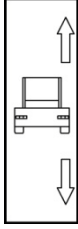

	<p><b>20. Switch outrigger left-hand front in / out</b>        Using this switch the outrigger on the left-hand at the front moves in or out        (see <i>Crane manual</i> § 5.2.2. <i>Crane set-up</i>).</p>
	<p><b>21. Switch outrigger beam left-hand rear in / out</b>        Using this switch outrigger beam on the left-hand at the rear moves in or out        (see <i>Crane manual</i> § 5.2.2. <i>Crane set-up</i>).</p>
	<p><b>22. Switch outrigger left-hand rear in / out</b>        Using this switch the outrigger on the left-hand at the rear moves in or out        (see <i>Crane manual</i> § 5.2.2. <i>Crane set-up</i>).</p>
	<p><b>23. Switch outrigger right-hand front in / out</b>        Using this switch the outrigger on the right-hand at the front moves in or out        (see <i>Crane manual</i> § 5.2.2. <i>Crane set-up</i>).</p>
	<p><b>24. Switch outrigger beam right-hand front in / out</b>        Using this switch the outrigger beam on the right-hand at the front moves in or out        (see <i>Crane manual</i> § 5.2.2. <i>Crane set-up</i>).</p>
	<p><b>25. Switch outrigger right-hand rear in / out</b>        Using this switch the outrigger on the right-hand at the rear moves in or out        (see <i>Crane manual</i> § 5.2.2. <i>Crane set-up</i>).</p>

Table 3-1  
 (page 4 of 12)

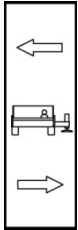





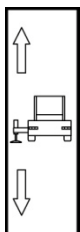
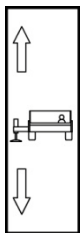
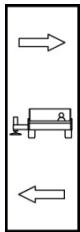
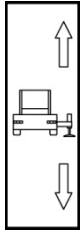

	<p><b>26. Switch outrigger beam right-hand rear in / out</b> Using this switch the outrigger beam on the right-hand at the rear moves in or out (see <i>Crane manual</i> § 5.2.2. <i>Crane set-up</i>).</p>
	<p><b>27. Safety switch outrigger control (locked)</b> Using this safety switch the outrigger control can be switched on or off. First the lock must be pressed down to press the safety switch (see <i>Crane manual</i> § 5.2.2. <i>Crane set-up</i>). If the outrigger control is enabled, <i>switches 19 to 26</i> and the remote outrigger control can be operated. The spring load of the truck is disabled when the outrigger control is enabled.</p>
	<p><b>28. Switch door window driver's side</b> (§ 3.1.1. <i>Windows</i>) This switch enables the driver to move the window at the driver's side up or down. Operating the switch is only possible when the ignition is turned on.</p>
	<p><b>29. Switch door window co-driver's side</b> This switch enables the driver to move the window at the co-driver's side up or down. At the co-driver's side there is also a switch mounted on the central console. Operating the switch is only possible when the ignition is turned on (§ 3.1.1. <i>Windows</i>).</p>
	<p><b>30. Switch cab lighting driver's side</b> Using this switch the cab lighting on the driver's side can be switched on or off.</p>
	<p><b>31. Switch cab lighting co-driver's side</b> Using this switch the cab lighting on the co-driver's side can be switched on or off.</p>
	<p><b>32. Switch steering system on-the-road / off-the-road</b> Using this switch the steering system can be switched to on-the-road mode and off-the-road mode (see § 12.1. <i>Steering modes</i>). To operate the steering system with the control panel for axle steering, it must be switched from on-the-road mode to off-the-road mode.</p>
	<p><b>33. Blinded</b></p>
	<p><b>34. Indicator</b> (see § 3.9.1. <i>Indicator</i>)</p>

Table 3-1  
(page 5 of 12)

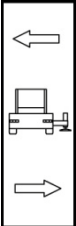

	<p><b>35. Main screen</b></p> <p>Using 6. <i>Main screen</i> enables the driver to navigate through the various screens (see § 3.9.2 <i>Main screen</i>). On the right side below the screen there is a knob mounted to set the contrast of the screen.</p>
	<p><b>36. Speedometer with odometer and trip recorder</b></p> <p>The speedometer shows the current speed of the vehicle by means of an analogue pointer [kph] [mph].</p> <p>The truck has a limited speed of 83 kph (52 mph).</p> <p>The total number of kilometres driven and the mileage of the trip recorder are shown on the display below the speedometer. The current time is also displayed.</p> <p>Time can be set on the digital tachograph.</p>
	<p><b>37. Revolution counter</b></p> <p>The revolution counter shows the current diesel engine speed by means of an analogue pointer [rpm x 100].</p>
	<p><b>38. Not in use</b></p>
	<p><b>39. Fuel gauge</b></p> <p>The fuel gauge shows the fuel stock by means of an analogue pointer (only possible when the ignition is turned on).</p>
	<p>When the fuel reaches a certain low level, the orange indicator lights up.</p> <p>At that moment there is about 50 litres of fuel present in the fuel tank.</p>
	<p><b>40. Coolant temperature gauge</b></p> <p>The coolant temperature gauge shows the temperature [°C] by means of an analogue pointer.</p>
	<p><b>41. Steering wheel</b></p>

Table 3-1  
 (page 6 of 12)

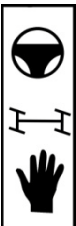
42. Control lever left

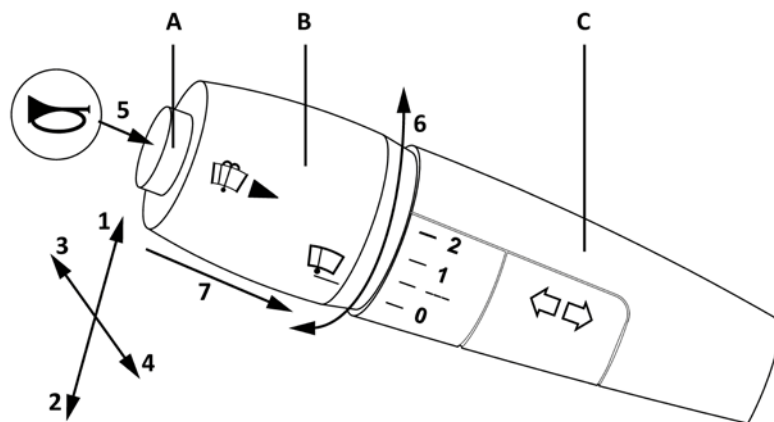

Picture 3-7

The functions of the left-hand control lever are:

- *Indicator lights* (§ 3.10. Signalling direction indicators);
- *Lighting* (light signal / low beam / main beam);
- *Horn*;
- *Screen wipers* (interval / speed / spraying).

**Direction of movement**

**1. Indicator lights right-hand;**

**2. Indicator lights left-hand:**

- When the lever is pressed to the tactile resistance, the indicator lights will flash three times;
- When the lever is pushed over the tactile resistance, the indicator lights will flash until the steering wheel is turned back to the centre position. Then the lever automatically moves back to its centre position;
- Indicator lights are only functioning when the ignition is turned on;

**3. Main beam:**

- Is only functioning when the ignition is turned on and the vehicle lights are switched on (7. Switch vehicle lights);

**4. Light signals (lever springs back to its centre position):**

- Is only functioning when the ignition is turned on;

**5. Horn (Picture 3-7, point A):**

- Is only functioning when the ignition is turned on.

Table 3-1  
(page 7 of 12)

**6. Switch windscreen wipers:**

The windscreen wipers are operated by turning the switch  
(Picture 3-7, point B) :

- *Position 0*: Screen wipers switched off;
- *Position --* : Screen wipers speed on interval of 5 seconds;
- *Position 1*: Screen wipers speed slow;
- *Position 2*: Screen wipers speed fast.

The screen wipers are only functioning when the ignition is turned on.

**CAUTION!**



**Always switch off the screen wipers at winter conditions before the ignition key is placed in the neutral position, to prevent damage to frozen windscreen wipers.**

**7. Windscreen washers (§ 3.7. Windscreen washer reservoir):**

- When the spring-loaded switch (Picture 3-7, punt B) is briefly pressed, the screen wipers will move up and down once;
- When the spring-loaded switch is pressed longer, the screen washer will start spraying.

When the switch is released, the windscreen washer stops spraying.

*Table 3-1  
(page 8 of 12)*

#### 43. Control lever right

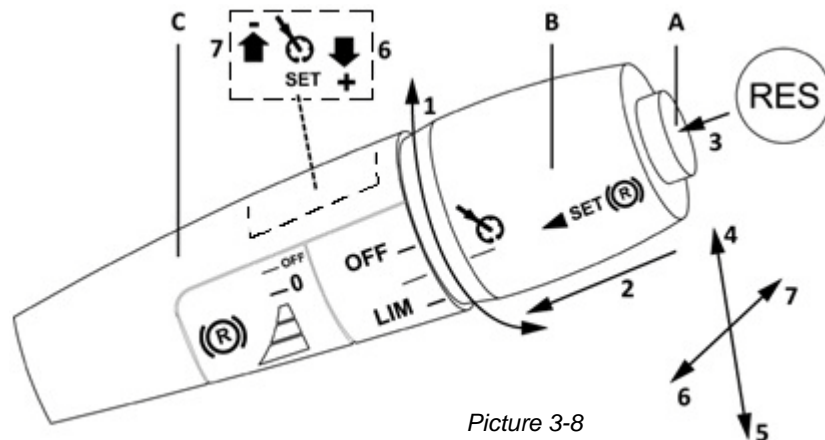

Picture 3-8

The functions of the right-hand control lever are:

- *Engine speed control (Engine Speed Control / ESC)* (see § 4.10.3. *Engine speed control (ESC)*);
- *Cruise control (CC)* (see § 4.10.1. *Cruise control*);
- *Retarder* (see § 4.8.4. *Retarder*);
- *Bremsomat* (see § 4.8.5. *Bremsomat*);
- *Variable vehicle speed limitation device* (see § 4.10.2. *Variable speed limitation device*).

1. The rotary switch (Picture 3-8, point B) has three positions:
  - -: Centre position / rest position;
  - OFF: The *cruise control / engine speed control* is switched off (spring returned);
  - LIM: The *variable vehicle speed limitation device* is switched on, (move back to centre position to switch off the device).
2. By pressing the rotary switch (Picture 3-8, point B), the *Bremsomat* is switched on (spring returned).
3. RES: by pressing this button, (regardless whether the truck drives or stands still) the stored speed or engine speed is recalled.
4. Switch off *Bremsomat* (spring returned).
5. Switch on the *retarder*. The retarder has three positions. Back in neutral position the retarder is switched off.
6. Increasing vehicle speed / engine speed of *speed control, cruise control or variable vehicle speed limitation device*.
7. Decreasing vehicle speed / engine speed of *speed control, cruise control or variable vehicle speed limitation device*.

Table 3-1  
(page 9 of 12)



	<p><b>44. Indicator aeronautic warning</b></p> <p>This green coloured indicator is active when the aeronautic warning is switched on (Picture 3-6, point 5) (see Crane manual § 5.1.6. Objects and obstacles).</p>
	<p><b>45. Ignition</b></p> <p>The ignition has three positions:</p> <ul style="list-style-type: none"> <li>- Off (0);</li> <li>- Contact (+30), when 56. Main switch truck is switched on;</li> <li>- Start (+15).</li> </ul> <p>Use the corresponding key. Start the engine by turning the ignition key clockwise and release the key as soon as the engine starts.</p>
	<p><b>46. Display automatic gear box (§ 3.9.3. Display gear box)</b></p>
	<p><b>47. Control panel steering system</b></p> <p>To manoeuvre the vehicle accurately, it is provided with an advanced steering system. This steering system, also called <i>rear axle steering</i>, provides the use of four different steering programs.</p> <p>The control panel can be used to select and set the steering programs. For using the <i>control panel steering system</i>, the steering system must be switched to off-the-road mode.</p> <p>Use 32. Switch steering system on-the-road / off-the-road to switch the steering system from <i>on-the-road mode</i> to <i>off-the-road mode</i> (see § 12.1. Steering modes).</p>
	<p><b>48. Direction indicator alert</b></p> <p>This alert indicates the status of the <i>direction indicators</i> and <i>hazard lights</i> (see § 7.4. Direction indicator).</p>
	<p><b>49. Navigation / multimedia system (DVD / CD-player / radio)</b></p> <p>For more information, see the supplied manuals.</p> <p>If the truck is not equipped with the optional side view camera, the image of the reverse drive camera will be shown on the multimedia screen.</p>
	<p><b>50. Monitor camera system (optional: side view camera)</b></p> <p>If the truck is equipped with the optional side view camera, the image of both the reverse drive camera and the side view camera will be shown on this monitor (see § 2.11. Side view camera (optional)).</p> <p>For more information, see the supplied manuals.</p>

Table 3-1  
(page 10 of 12)



	<p><b>51. Switch screen camera(s) / navigation system / multimedia system</b>              (see § 2.10. Reverse drive camera)</p> <p>By using this switch, the input source of the monitor can be chosen:</p> <ul style="list-style-type: none"> <li>• Central position: automatic;             <ul style="list-style-type: none"> <li>- Camera image at the rear, by putting the gear box in reverse;</li> <li>- Camera image side view camera, by using the right-hand flashing light;</li> </ul> </li> <li>• Up: side view camera (optional);</li> <li>• Down: reverse drive camera.</li> </ul>
	<p><b>52. Digital tachograph</b></p> <p>For more information, see the supplied manual.</p>
	<p><b>53. Heat control cab heater and air conditioning</b> (§ 3.11. Climate control)</p>
 	<p><b>54. Parking brake</b></p> <p>The parking brake shall take effect when the <i>parking brake lever</i> is moved backwards. In most rear position, the lever is locked again and the parking brake remains enabled (see § 4.8.2. Parking brake).</p> <p>The parking brake is discharged by pulling out the lever and move it forward.</p>
	<p><b>55. Control panel gear box</b></p>  <p style="text-align: right;"><i>Picture 3-9</i></p>

Table 3-1  
 (page 11 of 12)



  	<p><b>Gear lever</b> (Picture 3-9, point A):</p> <ul style="list-style-type: none"> <li>- M / A: Switch between <u>A</u>utomatic and <u>M</u>anual mode;</li> <li>- S: No function;</li> <li>- + (small): Select one gear up;</li> <li>- + (large): Select two gears up;</li> <li>- -- (small): Select one gear down;</li> <li>- -- (large): Select two gears down.</li> </ul> <p><b>Rotary switch</b> (Picture 3-9, point B):</p> <ul style="list-style-type: none"> <li>- N : <u>N</u>eutral;</li> <li>- D : <u>F</u>orward / <u>d</u>rive: drive forward;</li> <li>- R : <u>B</u>ackward / <u>r</u>everse: drive reverse;</li> <li>- Dm: <u>M</u>anoeuvre forward;</li> <li>- Rm: <u>M</u>anoeuvre backwards.</li> </ul> <p>At manoeuvring in Dm and Rm mode, the gear box is not switching gears (see § 4.5. Switching gears).</p>
	<p><b>56. Main switch truck</b></p> <p>This switch is used to switch on or off the electrical system of the truck. (The positive terminal is hereby interrupted.)</p> <p>If the switch is turned to the longitudinal vehicle direction, the electrical system is enabled (see § 4.4. Start diesel engine truck).</p> <p><i>The electrical system of the crane has an own main switch.</i></p> <div style="border: 1px solid black; padding: 10px; margin-top: 10px;"> <p style="text-align: center;"><b>ELECTRICAL VOLTAGE!</b></p> <p style="text-align: center;">At welding jobs, there must be no voltage on the electrical system.        However, never perform welding jobs without permission of Spierings Mobile Cranes.</p> </div>
	<p><b>57. Pressure gauge oil pressure</b></p> <p>The pressure gauge indicates the current oil pressure of the hydraulic system by means of an analogue pointer.</p>
	<p><b>58. Cigarette lighter</b></p> <p>24 Volt cigarette lighter.</p>

Table 3-1  
 (page 12 of 12)

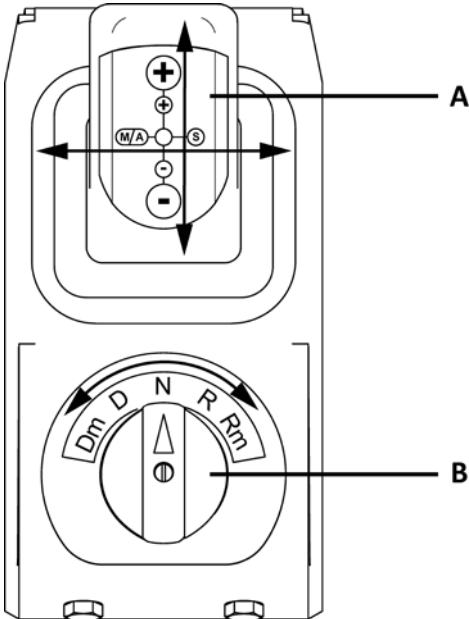

### 3.9.1. Indicators

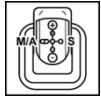
In *Picture 3-10* and *Table 3-3* the *indicators* on the control panel are shown.

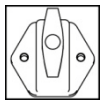

*Picture 3-10*

In some cases, the *warning light* or *error message light* will light up simultaneously with an indicator (see *Table 3-2*).

Function	Symbol	Description
<i>Warning light</i> (yellow)		At a less serious malfunction the <i>warning light</i> will be active. Check the systems whose symbols are activated. With an active <i>warning light</i> the vehicle need not to be stopped; take corrective actions at the first opportunity.
<i>Error message light</i> (red)		At a serious malfunction the <i>error message light</i> will be active, always in combination with the <i>buzzer</i> . <b>STOP IMMEDIATELY</b> and check the systems of which the symbols are activated. Contact Spierings Mobile Cranes.

*Table 3-2*

**CAUTION!**

When while driving the red *error message light* and *buzzer* become active:



- Stop the vehicle as soon as possible with increased caution;
- Park the vehicle in a safe place;
- Turn off the engine;
- Contact Spierings Mobile Cranes to take corrective actions.

**CAUTION!**



When while driving the yellow *warning light* becomes active, drive with increased caution, since the vehicle behaviour may differ from the normal vehicle behaviour.









Function	Symbol	Flashing (1 Hz)	Yellow light	Red light	Green light	Blue light	Description
Status ABS				X			<i>Not in use.</i> Not active during first 3 seconds when <i>ignition</i> truck is switched on.
Status main beam						X	Active during first 3 seconds when <i>ignition</i> truck is switched on.
						X	Active when main beam is enabled.
Status flashing light					X		Active during first 3 seconds when <i>ignition</i> truck is switched on.
		X			X		Active when the direction indicator or alarm lights are enabled.
Status				X			Active during first 3 seconds when <i>ignition</i> truck is switched on.
				X			Active when there is a serious malfunction in one of the systems. <b>STOP IMMEDIATELY!</b> The red error message light also appears on the screen.
Status warning light			X				Active during first 3 seconds when <i>ignition</i> truck is switched on.
			X				Active when there is a malfunction in one of the systems. <i>Stop at first opportunity!</i> The yellow warning light also appears on the screen.
Status flashing light trailer							<i>Not in use.</i> Not active during first 3 seconds when <i>ignition</i> truck is switched on.
Status retarder			X				Active during first 3 seconds when <i>ignition</i> truck is switched on.
							Active when retarder is enabled.
Status parking brake				X			Active during first 3 seconds when <i>ignition</i> truck is switched on.
				X			Active when parking brake is enabled.

Table 3-3

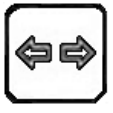
### 3.9.2. Main screen

The main screen shows (current) system information, which is divided on three different pages:

- General screen (see § 3.9.2.1. *Main screen: General screen*);
- Differential indication screen (see § 3.9.2.2. *Main screen: Differential indication screen*);
- Information screen (see § 3.9.2.3. *Main screen: Information screen*).



Switch 6. *Main screen* enables the user to navigate to various pages on the *main screen*.

#### 3.9.2.1. Main screen: General screen

In *Picture 3-11* the *general screen* is shown.

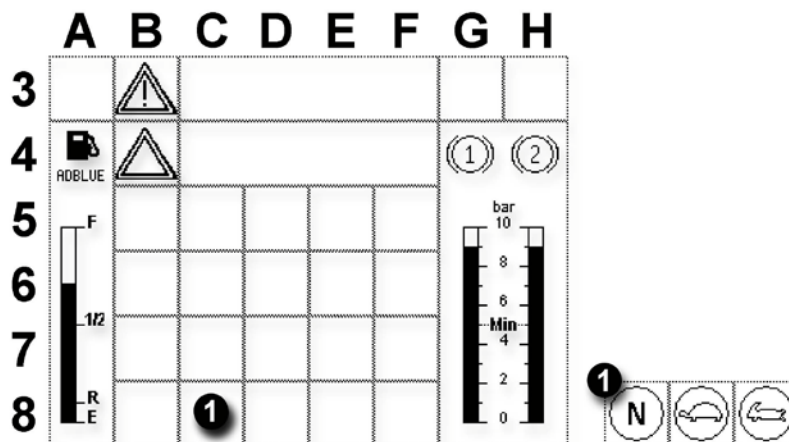

Picture 3-11

In the grid of *Picture 3-11* statuses, active settings or system errors are displayed by means of symbols or text lines.

*Picture 3-12* shows the possible symbols and text lines.

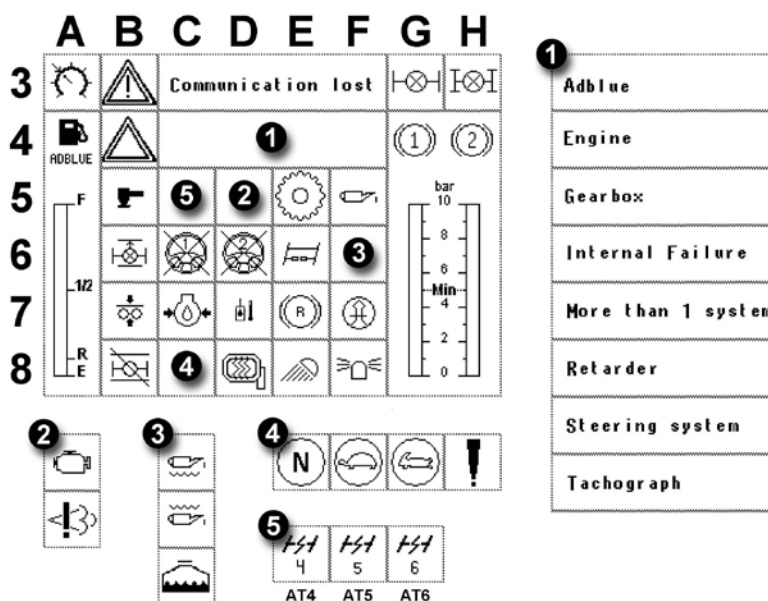

Picture 3-12

### Communication fault

In the centre of the *main screen*, there are two text lines visible. The top text line (*Picture 3-12, 3C to 3F*) is activated when a communication fault occurs in the *Canbus system*.

The relevant subsystem appears in the second text line (*Picture 3-12, 4C to 4F*).

In *Table 3-4* the text lines are briefly explained.

Position	Text line	Fault
3C to 3F	Communication lost	Communication fault in the <b>Canbus system</b> . This message always appears in combination with one of the messages mentioned below.
4C to 4F	Adblue	Communication fault with <b>EAS-system</b> . Also called <b>AdBlue-system</b> .
	Engine	Communication fault with <b>diesel engine</b> .
	Gearbox	Communication fault with <b>gear box</b> . In older types, the message <i>Transmission</i> is shown.
	Internal Failure	Internal communication fault.
	More than 1 system	Communication fault between a few systems.
	Retarder	Communication fault with <b>retarder</b> . In older types, the message <i>Intarder</i> is shown.
	Steering system	Communication fault with <b>steering system</b> . In older types, the message <i>Mobil Elektronik</i> is shown.
	Tachograph	Communication fault with <b>tachograph</b> .

Table 3-4

**Symbols**







Position	Function	Symbol	Flashing (1 Hz)	Flashing (2 Hz)	Yellow light	Red light	Buzzer	Description
3A	Cruise control							Cruise control is activated.
				X		X	X	Can-message of the engine is missing. The status of the <i>cruise control</i> cannot be determined.
3B								Error message light.
3G	Transversal differential lock							All <i>transversal differential locks</i> are activated.
			X					One or more <i>transversal differential locks</i> are activated or deactivated.
3H	Longitudinal differential lock							All <i>longitudinal differential locks</i> are activated.
			X					One or more <i>longitudinal differential locks</i> are activated or deactivated.
4A	AdBlue-level							AdBlue-level higher than approx. 10% of tank contents.
			X					AdBlue-level lower than approx. 10% of tank contents.
				X		X	X	AdBlue-level cannot be determined.
4B								Warning light.
4G	Air pressure circuit 1							The air pressure in circuit 1 is higher than approx. 5 bar.
			X			X	X	The air pressure in circuit 1 is lower than approx. 5 bar.

Table 3-5









Position	Function	Symbol	Flashing (1 Hz)	Flashing (2 Hz)	Yellow light	Red light	Buzzer	Description
4H	Air pressure circuit 2							Air pressure in circuit 2 is higher than approx. 5 bar.
			X			X	X	Air pressure in circuit 2 is lower than approx. 5 bar.
5B	Outrigger control							Outrigger control is enabled.
5C	Malfunction steering system (Figure 5 in symbol indicates total number of axles of the truck and is independent of the malfunction.)				X			Malfunction in the steering system. Read the fault on the <i>control panel steering system</i> .
			X		X			Malfunction in the steering system. Read the fault on the <i>control panel steering system</i> .
5D	Engine management		X		X			Warning from engine management. Read the fault on the <i>main screen</i> or use <i>DAVIE</i> .
			X			X	X	Warning from engine management. Turn off the engine and read the fault on the <i>main screen</i> or use <i>DAVIE</i> .
	EAS-malfunction		X		X			Malfunction in emission system (EAS). Read the fault on the <i>main screen</i> or use <i>DAVIE</i> . <b>CAUTION:</b> in some cases the power of the diesel engine can be decreased.
5E	Gear box malfunction		X			X	X	Malfunction in the gear box control. Turn off the engine and read the fault on <i>display gear box</i> .
7D	Temperature hydraulic oil		X		X			If temperature rises <b>above 80°C</b> : Solve problem as soon as possible.
			X			X	X	If temperature rises <b>above 100°C</b> : <b>Stop immediately and turn off engine.</b>
7F	Air filter		X		X			The air filter is clogged. Solve the problem immediately.

Table 3-5 (continued)

**3.9.2.2. Main screen: Differential indication screen**



By means of *switch 6* on the control panel, the *differential indication screen* (Picture 3-13) can be called.

The *differential indication screen* shows an overview of the enabled *transversal and longitudinal differential locks*.

The transfer case (C3) will also function as a *longitudinal differential lock*.

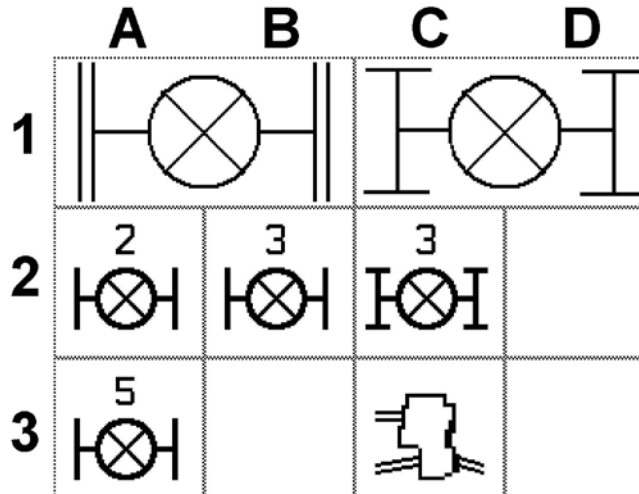

Picture 3-13

The enabled *transversal and longitudinal differential locks* are respectively shown left (column A and B) and right (column C and D) on the screen. The figure at the symbol corresponds to the relevant axle.

### 3.9.2.3. Main screen: Information screen



By means of *switch 6* on the control panel, the *information screen* (Picture 3-14) can be called.

In this screen, both the *passive* and the *current error messages* are displayed.

*Passive error messages* (PAS) are messages, which already have been corrected and after shown as passive on screen once, they will disappear.

The *passive error messages* can then no longer be shown on the information screen.

The *current error messages* (ACT) keep coming back when they are not corrected.

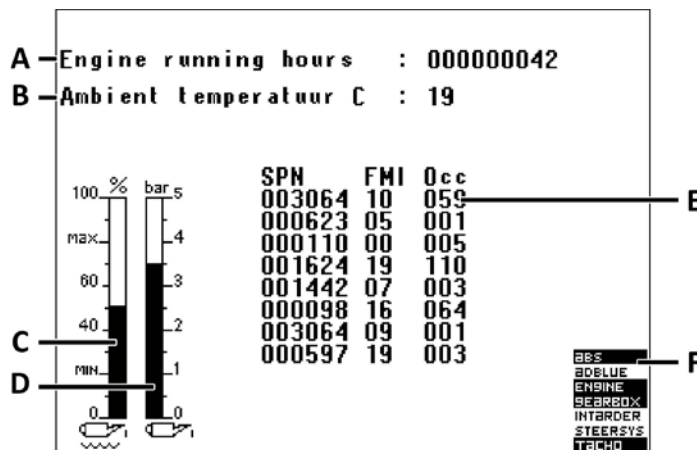

Picture 3-14

- A. Time counter diesel engine [hours];
- B. Ambient temperature [°C];
- C. Indication oil level [%]:
  - Flashing (1 Hz) when level is not measurable;
  - Flashing (2 Hz) when communication with CAN-bus is lost;
- D. Indication beam oil pressure [%];
  - Flashing (2 Hz) when communication with CAN-bus is lost;
- E. Recent error codes of the diesel engine:
  - If there are no recent errors, then this part of the screen is blank;
- F. Activity of the CAN-bus participants:
  - Active if the text appears black in a white background;
  - Not active if the text appears white in a black background.



### 3.9.3. Display gear box

The display shows information about the relevant status and/or the actual gear.

#### 3.9.3.1. Regular messages display gear box

Table 3-6 explains the regular messages on the *display gear box*.



Message	Description
	Gear box enabled in <i>neutral (N)</i> .
	Gear box enabled in <i>forward drive (D)</i> and <i>automatic mode</i> . In <i>automatic mode</i> all horizontal beams and arrow heads are shown. The figure shows the current gear (1 to 16).
	Gear box enabled in <i>forward drive (D)</i> and <i>manual mode</i> . The figure shows the current gear (1 to 16).
 	In <i>manual mode</i> the most ideal gear is advised. This is represented by the horizontal beams and arrow heads. Each beam represents one gear. <ul style="list-style-type: none"> <li>• <i>Example 1</i>: gear box in 5<sup>th</sup> gear and advised to switch forward to 6<sup>th</sup> gear;</li> <li>• <i>Example 2</i>: gear box in 6<sup>th</sup> gear and advised to switch back to 3<sup>rd</sup> gear.</li> </ul>
 	Gear box enabled in <i>backward / reverse (R)</i> . RL = 1 <sup>st</sup> gear backwards ( <i>Rear Low</i> ); RH = 2 <sup>nd</sup> gear backwards ( <i>Rear High</i> ).
	Gear box enabled in <i>manoeuvre forward (DM)</i> .
	Gear box enabled in <i>manoeuvre backward (RM)</i> .
	The electronics of the gear box perform a self check ( <i>Check</i> ). Active after turning the engine on.

Table 3-6

### 3.9.4. Malfunctions in the gear box

#### 3.9.4.1. Error messages display gear box

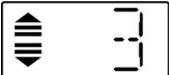
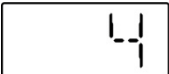
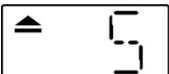
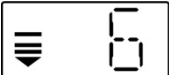
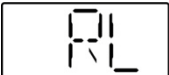
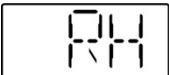
In *Table 3-7* error messages on the *display gear box* will be explained.

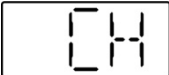





Message	Description
	<p>The air system does not produce enough pressure to be able to switch (<i>Air Less</i>).</p> <p>Wait a moment to determine if the air system will produce enough air pressure.</p> <p>When the message remains active: stop the vehicle as soon as possible provided that the road safety is not jeopardised.</p>
	<p>The clutch position is unknown (<i>Clutch Check</i>).</p> <p>Driving off is not possible.</p> <p>Contact Spierings Mobile Cranes when the message will not disappear.</p>
	<p>The clutch is overloaded (<i>Clutch Load</i>) and the buzzer is active.</p> <p>Stop directly with speeding up and switch back to a lower gear or put the gear box in <i>neutral (N)</i> to eliminate the overload.</p>
	<p>The clutch is worn out (<i>Clutch Wear</i>).</p> <p>Replace the clutch plates as soon as possible.</p>
  	<p>Electronic error message (<i>Electronic Error</i>).</p> <p>Malfunction in the communication between the gear box and the display.</p> <p>Carry out the following steps to correct the problem:</p> <ol style="list-style-type: none"> <li>1. Turn the key switch completely to the left (<i>position 0</i>).</li> <li>2. Wait for approx. 15 seconds.</li> <li>3. Turn the key switch to <i>ignition (position 1)</i>.</li> </ol> <p>Contact Spierings Mobile Cranes when the message keeps repeating itself.</p>
 	<p>Electronic error message (<i>Fault Pedal</i>).</p> <p>Malfunction in the communication between the gear box and the electronics of the accelerator.</p> <ol style="list-style-type: none"> <li>1. Take the foot off the accelerator.</li> <li>2. Turn the gear box in <i>neutral (N)</i>.</li> <li>3. Contact Spierings Mobile Cranes when the message will not disappear.</li> </ol> <p>Driving is no longer possible.</p>

Table 3-7



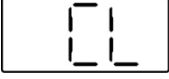
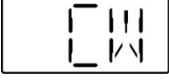
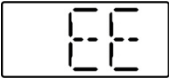



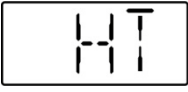

Message	Description
	The operating temperature is too high ( <i>High Temperature</i> ).
	The gear is unknown ( <i>Transmission Check</i> ). Driving off is not possible. Contact Spierings Mobile Cranes when the message will not disappear.
	System malfunction: appears when the gear can only work with restrictions. Driving further is possible, but the malfunction must be corrected as soon as possible. This prevents bigger problems with the gear box.
        	System malfunction and <i>STOP</i> (the buzzer is also active). <b>Major system malfunction: stop the vehicle as soon as possible.</b> <b>Continue driving is NOT PERMITTED!</b> Depending on the type of malfunction, in some cases it can be removed from the system. Carry out the following steps: <ol style="list-style-type: none"> <li>1. Turn the key switch completely to the left (<i>position 0</i>);</li> <li>2. Wait for approx. 10 seconds;</li> <li>3. Check if the error message disappears;</li> <li>4. Disable the <i>main switch truck</i>;</li> <li>5. Wait for approx. 10 seconds;</li> <li>6. Enable the <i>main switch truck</i>;</li> <li>7. Turn the key switch to <i>ignition (position 1)</i>.</li> </ol> When the error message appears again: <ul style="list-style-type: none"> <li>• Write down the code of the error message and contact Spierings Mobile Cranes immediately.</li> </ul>

Table 3-7 (continued)

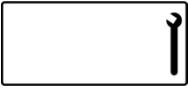
### 3.9.4.2. Error messages display gear box

The electronic system of the gear box will storage one or more error codes at an occurring error.  
 The explanations of the error codes may be requested from Spierings Mobile Cranes.  
 For a list of these codes is also referred to Annex 7 of this user manual.  
 Always write down the active and stored error codes before contacting Spierings Mobile Cranes.  
 When a system malfunction occurs, a 2-digit code appears in the display (see *Table 3-8*).



Message	Description
	2-digit error code (0 – 99). In this case error code: 53.
	3-digit error code (100 – 199). The four horizontal beams represent 100. In this case error code: 168.
	3-digit error code (200 – 299). The four horizontal beams with arrow heads represent 200. In this case error code: 227.

Table 3-8

### 3.9.4.3. Active error message(s) display gear box

These error codes refer to current error messages.

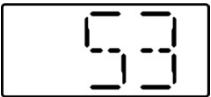

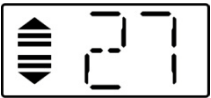
1. Turn the gear box in *neutral (N)*:



- On the *display gear box* then *N* is displayed;



2. Push the gear lever forward and keep it pressed that way;



3. The active error codes appear (in turn) on the *display gear box* as long as the gear lever is pushed forward.

### 3.9.4.4. Error history display gear box

These error codes refer to error messages, which have occurred in the past.

To request these codes, carry out the following steps:



1. Push down the accelerator;



2. Turn the gear box in *neutral (N)*:



- On the *display gear box* then *N* is displayed;



3. Push the gear lever forward and keep it pressed that way;



4. The stored error codes appear (in turn) on the *display gear box* as long as the gear lever is pushed forward.

### 3.9.5. Control panel steering system

To manoeuvre the truck accurately, it is provided with an advanced steering system. This steering system (also called *rear axle steering*) provides the use of four different steering programs, which are distinguished from each other by the difference in steering characteristics of the rear axles:

1. *Small turning circle:* In this mode an extra small turning radius is possible;
2. *Manual:* In this mode the position of the rear axle(s) is set manually;
3. *Crab steering:* In this mode all steered axles are steered in the same direction;
4. *Wall steering:* In this mode it is possible to drive away from an obstacle with minimum swing of the back of the truck.

#### CAUTION!

For all steering programs counts that the crane must be in *transport position*. So a steering program may NEVER be active while driving the vehicle with the crane folded out.



The *transversal differential lock* may also NEVER be active when a steering program is active.



When using the *control panel steering system (47)*, the steering system must be in *off-the-road mode*.

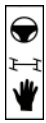

Use *switch 32 on the control panel* to switch the steering system between *on-the-road mode* (steering wheel) to *off-the-road mode* (hand).

**This may only be done when the vehicle stands still!**

After enabling the *off-the-road mode*, the maximum speed of the vehicle will be limited to 15 kph (9.4 mph).

For more information, see § 4.13. *Off-the-road driving*.

**CAUTION!**



**Switching between on-the-road mode and off-the-road mode (32. Switch steering system on-the-road / off-the-road on the control panel) may only be done when the vehicle stands still.**

**CONDITIONS**



**When switching from off-the-road mode to on-the-road mode (32. Switch steering system on-the-road / off-the-road on the control panel), take care that all axles are first brought in straight position before driving away.**

### 3.9.5.1. Keys control panel steering system

This control panel has eight keys (see *Picture 3-15*):

- Navigation keys (A to D);
- Steering program keys (1 to 4).

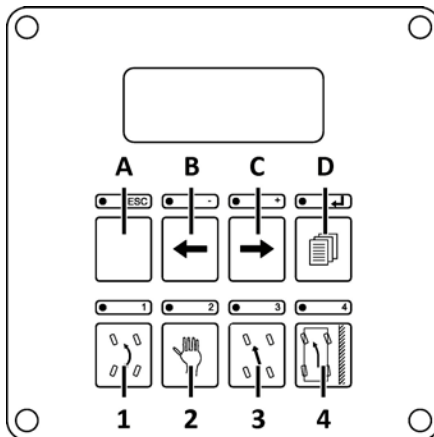

*Picture 3-15*

The functions are shown in *Table 3-9* on the following page.









Key	Function
	<p>A. <i>Escape key (ESC):</i></p> <ul style="list-style-type: none"> <li>Exit an active menu;</li> <li>Cancel an action without saving the settings;</li> <li>To go back one character in an input field.</li> </ul>
	<p>B. <i>Minus key (--):</i></p> <ul style="list-style-type: none"> <li>To go back one menu item;</li> <li>Reduce a value by 1.</li> </ul>
	<p>C. <i>Plus key (+):</i></p> <ul style="list-style-type: none"> <li>To go forward one menu item;</li> <li>Increase a value by 1.</li> </ul>
	<p>D. <i>Enter key:</i></p> <ul style="list-style-type: none"> <li>Activate selected menu item;</li> <li>Confirm value;</li> <li>Save value;</li> <li>To go forward one character in an input field ;</li> <li>Activate main menu (press 3 seconds).</li> </ul>
	<p>1. Steering program <i>Small turning circle:</i></p> <ul style="list-style-type: none"> <li>Activates steering program <i>Small turning circle.</i></li> </ul>
	<p>2. Steering program <i>Manual:</i></p> <ul style="list-style-type: none"> <li>Activates steering program <i>Manual.</i></li> </ul>
	<p>3. Steering program <i>Crab steering:</i></p> <ul style="list-style-type: none"> <li>Activates steering program <i>Crab steering.</i></li> </ul>
	<p>4. Steering program <i>Wall steering:</i></p> <ul style="list-style-type: none"> <li>Activates steering program <i>Wall steering.</i></li> </ul>

Table 3-9

The steering programs may be used consecutively without additional measures or restrictions.

- The red indicator above the key is activated when the steering program can be carried out successfully;
- The red indicator flashes when the steering position of the axles cannot be determined:
  - Turn the steering wheel until the indicator is continuously active.

### 3.9.5.2. Display control panel steering system



After turning on the *ignition* of the truck, the display of the *control panel steering system* becomes active. The display shows the current status of the steering system by default (Table 3-10).

Recalling other information and making of advanced settings will be done in the main menu (see § 3.9.5.3. *Structure main menu control panel steering system*).

**CAUTION!**



**In case a malfunction in the steering system occurs, contact Spierings Mobile Cranes at all times!**





Message	Description
After turning on the <i>ignition</i> of the truck:	
  	Setting position of the axle, depending on the chosen steering program.
After pressing the <i>Enter</i> key for 3 seconds or when malfunctions occur:	
	The system is ready for use.
	The system is on <i>stand-by</i> , the diesel engine is not running. Start the diesel engine to use the steering system.
	There is an active failure in the control occurring. Text line 2 specifies the relevant error message [xxx-xxx-xx]. Contact Spierings Mobile Cranes. (malfunction in rear axle steering) See <i>Annex 6</i> for the explanation of the error codes.
	There is an error in the steering computer ( <i>U-fault</i> ). Error code: [error U xxx] <b>Stop immediately and turn the ignition off!</b> Contact Spierings Mobile Cranes. (malfunction in rear axle steering)
	There is a communication failure between the control panel and the steering computer in the centre console.

Table 3-10

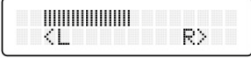

### 3.9.5.3. Structure main menu control panel steering system

Follow the steps to activate the *main menu*:

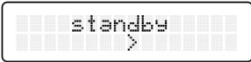
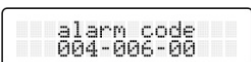
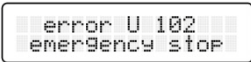
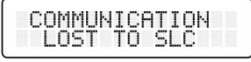

1. Press the *Enter* key for 3 seconds:
  - *READY, stand-by* or *alarm code* will appear on the display;
2. Press the *Enter* key again for 2 seconds:
  - The *main menu* will be activated.

The structure of the *main menu* is shown in *Picture 3-16*.

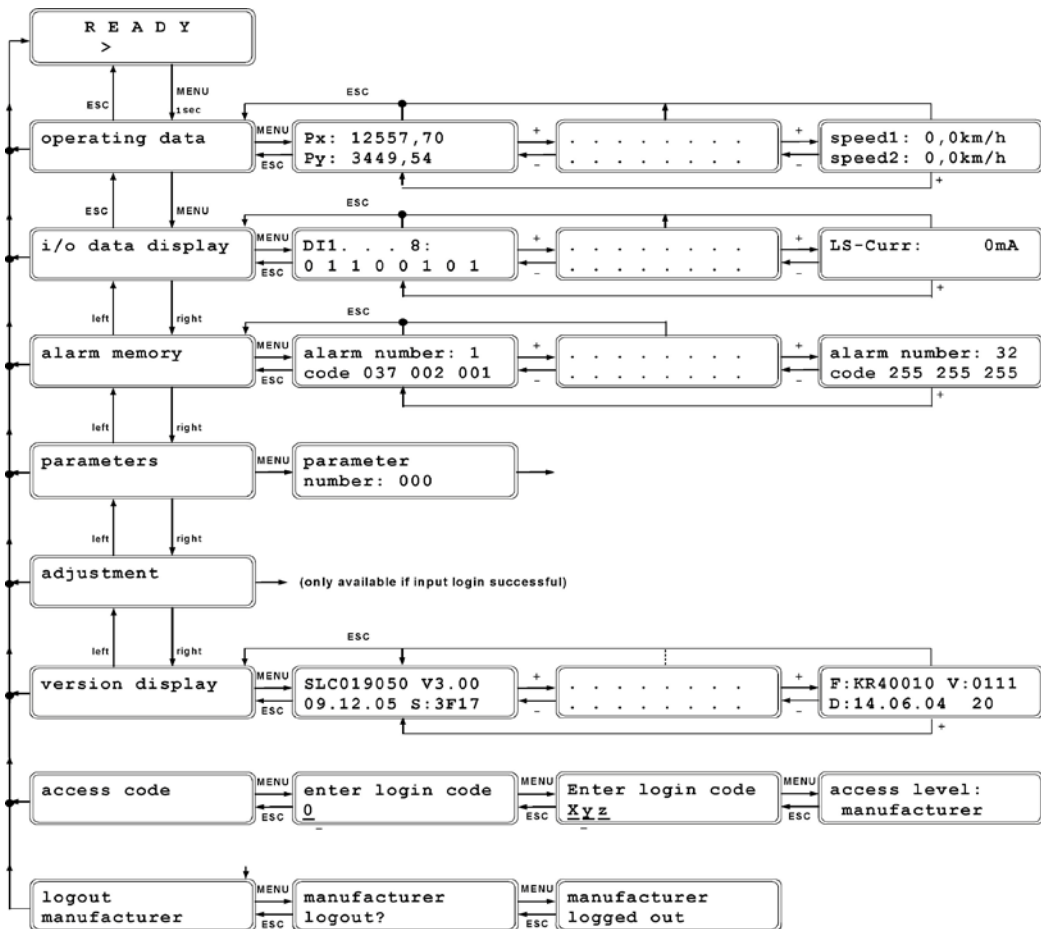

Picture 3-16

The submenus have the following functions (see *Table 3-11*).

Submenu	Function
Operating data	Operating information such as steering angles, vehicle speed etc.
I/O data display	Overview of the input/output of the steering computer.
Alarm memory	Overview of the active and passive error messages.
Parameters	Setting and changing parameters.
Alignment	Calibrate steering angles of the axles.
Version display	Overview software version.
Access code	Input log-in code for manufacturer's service (a.o. for resetting the error history and calibrating the steering angles of the axles).
Logout manufacturer	Log-out from manufacturers service.

*Table 3-11*

### 3.9.6. Malfunctions in the steering system

**CAUTION!**



**In case a malfunction in the steering system occurs, always contact Spierings Mobile Cranes. Stop as soon as possible to solve the problem.**

**CAUTION!**



**In case of a malfunction of the rear axle steering, the possibility exists that the rear axle will center itself. This centering affects the turning circle, which will increase.**

#### 3.9.6.1. Read malfunctions on the control panel of the steering system

##### **Active malfunctions**

Active malfunctions always appear directly on the display of the *control panel steering system*.

When a few malfunctions are simultaneously active, they will appear in a row.



On the *main screen* the symbol *malfunction steering system* appears simultaneously.

- Write down the error codes and contact Spierings Mobile Cranes.

Malfunctions in the steering system can be caused by:

- Malfunctions in the electric system;
- Malfunctions in the hydraulic system;
- Malfunctions in actuators and sensors;
- Malfunctions in the communication between the components.

See *Annex 6* for the meaning of the error codes.

In case of a malfunction of the rear axle steering, the possibility exists that the rear axle will centre itself. This centering affects the turning circle, which will increase.

Stop as soon as possible to solve the problem.

### Error history

In the memory of the computer, the last 32 malfunctions were stored.

The so-called *alarm memory* can be recalled as follows:

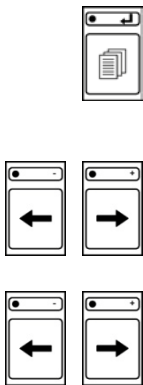

1. Press the *Enter key* for 3 seconds:
  - *READY*, *stand-by* or *alarm code* appears on the display;
2. Press the *Enter key* again for 2 seconds:
  - The *main menu* will be activated;
3. Use the *plus key* (+) and/or the *minus key* (--) to navigate to *alarm memory*;
4. Press the *Enter key* once more:
  - The menu item *alarm memory* is chosen;
5. Use the *plus key* (+) and/or the *minus key* (--) to navigate through the error history:
  - If there are some active failures, they are also displayed here.

There are up to 32 malfunctions stored; Index 1 (youngest) t/m 32 (oldest malfunction) (see *Picture 3-17*).

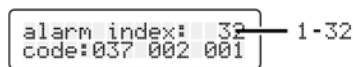

*Picture 3-17*

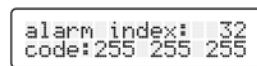

*Picture 3-18*

When error code 255-255-255 is displayed (*Picture 3-18*), then this means that the given index contains no malfunctions.

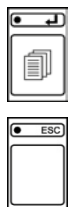

6. Press the *Enter key* for additional information related to the malfunction:
  - Date, time and number of times that the malfunction has occurred;
7. Press the *Escape key* to exit the error memory;
8. Press the *Escape key* once again to exit the *main menu*.

### 3.9.6.2. Resetting error history control panel steering system

**CAUTION!**

The next action should only be performed after contacting Spierings Mobile Cranes.

 For this action log-in of the manufacturers service is necessary. Use the manufacturers service exclusively for resetting the error history. For the use of other settings, permission from Spierings Mobile Cranes is also needed.

Resetting the error history can be performed by the following actions:

1. Press the *Enter* key for 3 seconds:
    - *READY*, *stand-by* or *alarm code* appears on the display;
  2. Press the *Enter* key again for 2 seconds:
    - The *main menu* will be activated;
  3. Use the *plus* key (+) and/or the *minus* key (-) to navigate to *access code*;
  4. Press the *Enter* key once more:
    - The menu item *access code* is chosen;
  5. Enter the log-in code. Entering is done by character; to do this, use the *plus* key and/or *minus* key and confirm each character with the *Enter* key.
    - There is now logged-in as manufacturer;
  6. Use the *plus* key (+) and/or the *minus* key (-) to navigate to *alarm memory*;
  7. Press the *plus* key till *memory clear* appears on the display;
  8. Press the *Enter* key and the error history will be deleted.
- The indices 1 to 32 show error code 255 255 255; the index is empty (see *Picture 3-19*).

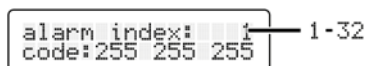

Picture 3-19

### 3.10. Signalling direction indicators

The signalling of the direction indicators (*Picture 3-20*) shows the status of the alarm lights and direction indicators.

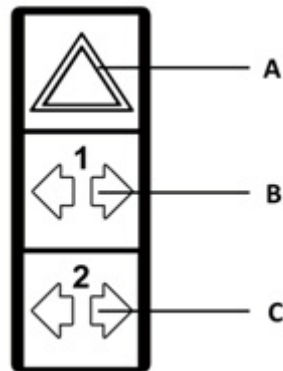

Picture 3-20

**A. Indicator alarm lights (red):**

- Flashes at enabled alarm lights (*switch 4 on the control panel*);

**B. Direction indicators 1 (green):**

- Flashes at operated direction indicator (*control lever left 42 on steering column*);

**C. Direction indicators 2 (green):**

- Flashes at operated direction indicator at a mounted buffer beam or trailer.

**CAUTION!**

**When while driving on the public road no trailer is used, driving with the unfolded buffer beam (including lighting) is required by law (see § 4.14. Driving with a trailer).**

#### 3.10.1. Malfunctions direction indicators

Malfunctions of the direction indicators are shown by direction indicators 1 and 2 (see *Table 3-12* and *Table 3-13*).

**Signalling of the direction indicators at folded buffer beam/mounted trailer:**

Direction indicator operated	Signalling
No defect light	Both direction indicators 1 and 2 are flashing.
One defect light	Direction indicator 1 flashes and 2 remains off.
Two defect lights	Both direction indicators 1 and 2 remain off.

Table 3-12

**Signalling of the direction indicators at unfolded buffer beam/without mounted trailer:**

Direction indicator operated	Signalling
No defect light	Direction indicator 1 flashes and 2 remains off.
One or more defect lights	Both direction indicators 1 and 2 remain off.

Table 3-13

The indicator *alarm lights* (see *Picture 3-20, point A*) shows in contrast to the *direction indicators 1 and 2* (see *Picture 3-20, points B and C*) no malfunctions of the lights.

**3.10.2. Operating system signalling direction indicators**

On the system there are four lamps of 21 W each connected to the direction indicators (per vehicle side):

- Direction indicator at the front of the truck;
- Direction indicator at left/right side of the truck;
- Direction indicator at the rear of the truck;
- Direction indicator on buffer beam or trailer.

The flashing relays measures the power consumption at the enabled direction indicator.

This corresponds with:

- 4 x 21 W, then both direction indicators are operated (*Picture 3-20, points B en C*);
- 3 x 21 W, then only direction indication 1 is operated (*Picture 3-20, point B*);
- 2 x 21 W or less, then both direction indicators remain off.

### 3.11. Climate control

#### 3.11.1. Control panel

The control panel (*Picture 3-21*) of the heaters and the air conditioning consists of three *rotary switches A, B and C* and one *switch D*.

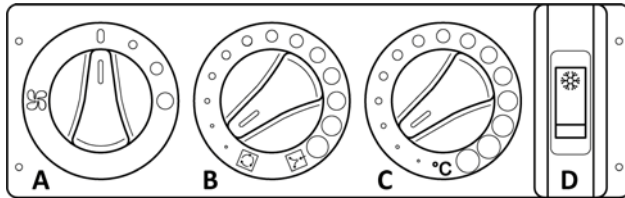

Picture 3-21

#### A. Rotary switch *enable fan and adjust air yield*:

- **Enable fan:** turn the rotary switch clockwise:
  - There are three settings possible, with ascending air yield;
- **Disable fan:** turn the rotary switch fully counterclockwise;

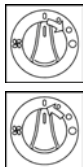

#### B. Rotary switch *circulating air / outdoor air ratio*:

- **More circulation:** turn the rotary switch counterclockwise;
- **More outdoor air:** turn the rotary switch clockwise;

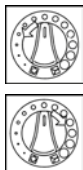

#### C. Rotary switch *heating mode*:

- **More heat:** turn the rotary switch clockwise;
  - The air in the heating system is heated by the hot coolant in the radiator of the diesel engine. The heater only functions when the (warm) diesel engine is running;
- **Less heat:** turn the rotary switch counterclockwise;

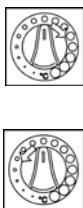

#### D. Switch *enable/disable air conditioning*:

- **Airco enabled:** Press the top side of the switch:
  - The indicator lights up;
  - The fan should be enabled when the airco is going to be enabled (*rotary switch A clockwise*);
- **Airco disabled:** Press the lower side of the switch:
  - The indicator goes off.

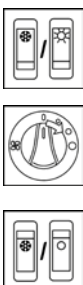

### Regulate air distribution

If desired, the air vents in the cab can be tilted and/or twisted to regulate the air distribution.

### Ventilating



At maximum circulating air (rotary switch *circulation air /outdoor air ratio* fully turned counterclockwise), it is advised to ventilate regularly with fresh outdoor air.

The oxygen percentage in the air can restore itself.

This can be done in the following ways:

- Open (temporarily) a door window:
  - Using the switches *door window driver's side* and *door window co-driver's side* on the control panel (see § 3.9. *Control panel*), the door windows at both sides of the cab can be moved upwards/downwards;
- Decrease (temporarily) the ratio of the circulating air and the outdoor air:
  - Turn the rotary switch *circulation air /outdoor air ratio* clockwise.



### 3.11.2. Use of the air conditioning

Avoid excessive cooling by use of the air conditioning. It is recommended to apply the rule of a difference between outdoor and indoor temperature of maximum 10 to 14 ° C.

Exposure of the human body to frequent and high temperature changes may lead to an uncomfortable feeling, often only noticeable after leaving the truck cab.

Avoid exposure to cold air flows directly on the body (this is experienced as draft).

Rotate the air vents so that the cold air can first mix with the hot air in the cab. This creates a uniform temperature in the truck cab.

For efficient and effective use of the airco system, it is advised to close all doors and door windows.

If the desired cab temperature is reached, the air yield of the fan can be turned back:

- Turn the rotary switch *enable fan and adjust air yield* counterclockwise.



#### INFORMATION!



To prevent development of odours by fungi, it is advised to turn off the air conditioning a couple of minutes before turning off the engine.

#### INFORMATION!



It is advised to turn on the air conditioning weekly (also in winter) relating to the internal lubrication of the system.



### 3.11.3. Dehumidification of the air

The air conditioning is an excellent tool to dehumidify the truck cab because of the use of heating and air conditioning simultaneously. The system can be set up in such a way, that the cooling and the heating power eliminates itself, making no temperature differences in the truck cab.

To dehumidify the air, the following actions must be carried out:

1. Enable the fan:
  - Turn rotary switch *enable fan and adjust air yield* clockwise;
2. Enable the air conditioning:
  - Press switch *enable air conditioning*;
3. Set the heating mode preferably on maximum:
  - Turn rotary switch *heating mode* clockwise;
  - If desired, the heating mode can be adjusted in such a way that the cooling can be eliminated by the air conditioning;
4. Set the ratio between circulating air and outdoor air fully to circulating air:
  - Turn rotary switch *circulating air / outdoor air ratio* fully counterclockwise.



The dryness of the air is essentially determined by the air conditioning.

### 3.12. Navigation and multimedia system (DVD/CD-player/radio)

The navigation and multimedia system is situated on the right side of the control panel in the truck cab. If the vehicle is not equipped with an optional side view camera, the image of the reverse drive camera will be shown on the screen of the multimedia system.

Using the button on the right side of the display, the various screens can be changed.

The user manual of the navigation and multimedia system are supplied separately.



## 4. Driving

### 4.1. General

**CAUTION!**



The driver of the vehicle shall at all times comply with the applicable directives and traffic regulations.

**CAUTION!**



Make sure that the indicated weights, dimensions and axle loads are applied and not exceeded by actual loads.

**CAUTION!**



The rear of the vehicle swings during cornering.

The vehicle has been authorised in accordance with the national road traffic rules.

For driving on public roads, the crane must be brought in the so-called *transport position*.

When driving and manoeuvring, the driver must be beware of the unusual shape, size, mass and handling characteristics of the vehicle:

- The height of the vehicle:
  - Watch out for low passages and low-hanging objects;
- The width of the vehicle:
  - At narrow passages it can cause traffic disruption;
- Parts of the crane, which protrude at front and rear;
- Handling: because of the rear axle counter steering (up to 50 kph (31 mph)), the vehicle has a small(er) turning circle, which causes the back to swing;
- The mass of the vehicle:
  - Watch out with a.o. bridges, embankments and viaducts on possible weight restrictions;
- Axle load: in countries with rules according EEC, axle loads higher than 12 tonnes for driving on public roads are not allowed.

**CAUTION!**

***Follow the prescribed axle load and the total weight!***

**By exceeding the axle load and the total weight, the *braking power will be reduced*. The wear on the brake linings and the chance that the brakes overheat will increase. Also the service brake, parking brake and the steering mechanism no longer meet the requirements. The *service life* of parts, which are overloaded by larger axle loads (such as brakes, tyres, rims, axles, drive components, suspension and steering mechanism) becomes shorter.**



## 4.2. Running-in the vehicle

### CAUTION!



- Stop the vehicle directly at a defect or occurring malfunction;
- During the *running-in period* it is better not to overload the engine too much.

Follow the instructions mentioned below during the *running-in period*:

- Keep a close eye to the control panel.

For more information, see § 4.3.2. *CHECKLIST: Check vehicle lights.*



- The *warning light* and/or *error messages light* (and *buzzer*) may not be active;



- The temperature gauge of the coolant:

- o The *orange indicator* may not be active simultaneously with the *red error message light* and the *buzzer*. The temperature of the coolant is higher than or equal to 110°C.

**Take actions immediately!**



- The symbol *coolant level* on the *main screen* may not be active;



- The symbols *oil level* on the *main screen* may not be active:

- o Check if there is no engine oil leaking;



- The symbol *oil pressure* on the *main screen* may not be active;



- The symbols *air pressure circuit 1* and *2* on the *main menu* may not be active (while driving the vehicle):

- o Check if there is no hydraulic oil leaking;



- *Air pressure gauge circuit 1* and *2* on the *main screen* should indicate 8 - 10 bar (while driving the vehicle):

- o Check if there is no air leaking from the system;



- Fuel gauge:

- o Check if there is no fuel leaking;



- The *AdBlue level indicator* on the *main screen*:

- o Check if there is no *AdBlue* leaking.

- Carefully break-in the new brake linings (see *Breaking-in new brake linings* on the next page).

### Maintenance regarding the driving-in

Carry out the following maintenance after driving the first 50 km and 100 km:

- Tighten the wheel nuts;
- Check the *coolant level diesel engine truck*;
- Check the *oil level diesel engine truck*;
- Check the *oil level gear box* and the *oil level transfer case*;
- Check the complete *drive line truck* for loose parts and leaks:
  - Engine;
  - Gear box and transfer case;
  - Differentials;
  - Drive shafts;
  - Wheel suspension.
- Check the tyres:
  - Tyre pressure (see § 11.5.2. *Tyre pressure*);
  - State of the tyres.

### Breaking-in new brake linings

**CAUTION!**



**During the breaking-in period of the brake linings, long lasting and powerful operation of the service brake is not recommended.**

New brake linings must always be carefully broken-in.

Break-in the brake linings by operating the service brake with short intervals in the speed range of 10 up to 60 kph (6.2 up to 37.5 mph).

Avoid prolonged and unacceptable powerful use of the brake. The maximum temperature of the brake drums and brake discs may not exceed 200°C.

The breaking-in period for the brake lining is normally approx. 500 km.

**CAUTION!**



**For security reasons, avoid using the retarder and engine brake during the breaking-in period of the brake lining. Otherwise the breaking-in period of approx. 500 km is not sufficient for carefully breaking-in the brake lining.**

### Check

**CAUTION!**



**Perform the checks mentioned below only if the road safety permits. Do not bring other road users in danger!**

Using the following test it can be determined whether the brake lining has successfully passed the breaking-in period:

- After the breaking-in period the vehicle with a speed of 60 kph (37.5 mph) must grind to a halt within 4.0 seconds.

### 4.3. Before driving

#### 4.3.1. CHECKLIST: Before driving on public roads

**CAUTION!**



The issues in this checklist are just a brief explanation.  
For further explanation, procedures and safety regulations see the related paragraph.

1. Check if the crane is correctly folded (see *crane manual, Chapter 8. Folding crane*):
  - Check if the rotating ballast is correctly locked and secured;
  - Check if the upper frame is correctly locked on the truck;
  - Check if the sliding block on *ty bar S-T* lies along the other ty bars (related to the maximum driving height);
  - Check if the *diesel engine crane* is disabled;
  - Check if all four outrigger beams and outriggers are fully retracted and the outrigger plates are moved to the *transport position* and secured;
  - Check if the *outrigger control* is disabled;
2. Check the maximum width of 3.00 m and driving height of 4.00 m:
  - Check if there are no protruded parts above the legally permitted length, width and height;
3. Check the tyres and the tyre pressure (see § 11.5.2. *Tyre pressure*);
4. Check if the buffer beam is correctly unfolded, locked and connected:
  - When using a trailer, see the separately supplied documentation;
5. Check the equipment and the tools:
  - Check if the (lifting) tools are properly stowed;
  - Check if cabinets and boxes are well closed;
  - Check if there are no (loose) objects on the crane platform;
6. Check the fluid level of the windscreen washer reservoir (see § 3.7. *Windscreen washer reservoir*);
7. Carry out *CHECKLIST: Start diesel engine truck* (see § 4.4.1. *CHECKLIST: Start diesel engine*);
8. Check the vehicle lights (see § 4.3.2. *CHECKLIST: Check vehicle lights*);
9. Enable necessary or legally required *vehicle lights*;
10. If necessary, enable the *mirror heating*;





11. Check if the *lighting* of the crane is disabled:

- *Work lamps* off;
- *Work lamps at outrigger beams* off;
- *Rotaflares on ballast* off;
- *Aeronautic warning lights* off;



12. Check if the transfer case is switched to *on-the-road mode*;



13. Check if the steering system is set to *on-the-road mode*;



14. Check on the main screen if all longitudinal differential locks and *transversal differential locks* are disabled (see § 4.13.4. *Differentials*);



15. Check if the *release axle height adjustment* is disabled (see § 4.13.2. *Axle height adjustment*);



16. Level the truck (see § 4.13.2.3. *Levelling*);

17. Adjust the driver's seat (see § 3.2.1. *Seat adjustments*);

18. Adjust the wing mirrors;

19. Check if there are no persons on or around the vehicle.

4.3.2. CHECKLIST: Check vehicle lights

**CAUTION!**



Repair defect lights before driving on public roads.  
The risk of accidents increases by defect vehicle lights.

**CONDITIONS**



- **Main switch truck** must be enabled;
- The **ignition** must be turned on;
- A second person is needed to check the brake lights.

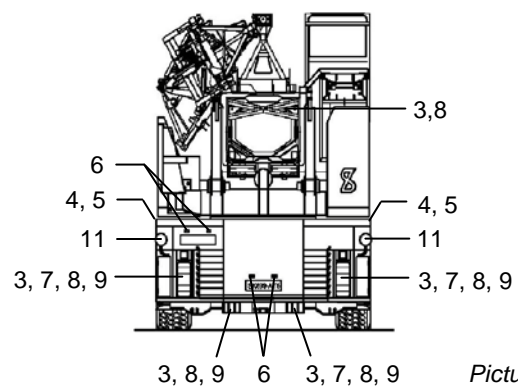
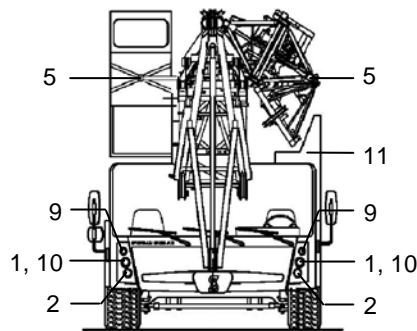
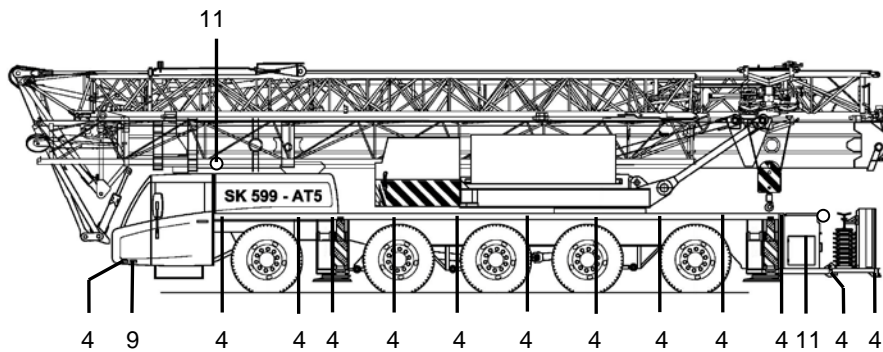

Picture 4-1

**Check the vehicle lights:**



1. Enable the vehicle lights fully (*position 2*) by using switch *vehicle lights*;
2. Check the vehicle lights (see *Picture 4-1*):
  - *Parking light (1)*;
  - *Low beam (2)*;
  - *Rear lights (3)*;
  - *Side marking lights (4)*;
  - *Contour lights (5)*;
  - *License plate lights (6)*;
  - *Control panel lighting*;



3. Enable the fog tail light by using switch *fog tail light*;





4. Check if the *fog tail light (7)* lights up;
5. Press the *brake pedal*;
6. Check if the *brake lights (8)* light up;



7. Enable the hazard warning lights by using switch *hazard warning lights*;
8. Check if the *direction indicators (9)* light up;



9. Enable the *main beam* by using the *control lever left* on the steering column;
10. Check if the *main beam (10)* lights up;



11. Enable the *rotaflares* by using switch *rotaflares*;
12. Check if the *rotaflares (11)* light up.

**CAUTION!**

If a trailer is attached to the rear of the vehicle, the trailer lighting must be checked as well.



For more information, see the documentation related to the trailer.

#### 4.4. Start diesel engine truck

##### 4.4.1. CHECKLIST: Start diesel engine

**CAUTION!**

The issues in this checklist are just briefly explained.



For further information, procedures and safety regulations, see the related paragraph.

**CAUTION!**



Not following the start instructions may lead to damage of the starter motor.

**CAUTION!**



The maximum duty cycle of the starter motor is 30 seconds. If the starter motor will not turn during this time, let the starter motor cool-down for at least 2 minutes. Operate the starter motor continuously (up to 30 seconds) till the starter motor starts. When the starter motor is still not running during this time, then let the starter motor cool-down for at least 30 minutes before repeating the procedure.

**TOXIC SUBSTANCES!**



Do not let the diesel engine run in an enclosed or unventilated space because of risk of choking hazard!

If the outdoor temperature is lower than -10°C, also carry out § 4.4.2. *CHECKLIST: Start diesel engine in cold environment.*



1. Check the hydraulic oil level;
2. Check if the *parking brake* is enabled:
  - If not: move the parking brake lever backwards till it is locked;



3. Enable the *main switch truck*;



4. Turn the *ignition* on:



- Insert the *ignition key truck*;
- Turn the *ignition key* one position clockwise:
  - Various systems of the truck will start up;

5. Check the control panel lights on the control panel;
6. Check the instruments on the control panel;
7. Check the *coolant level* of the *diesel engine truck*;
8. Check the *engine oil level* of the *diesel engine truck*;
9. Check the *fuel level* on the control panel;



10. Check the *AdBlue level* on the *main screen*:
  - The symbol flashes (1 Hz) when the *AdBlue level* is lower than 10%;



11. Check if the gear box is in its *neutral position (N)*:



- If not: Put the gear box in the *neutral position (N)* by using the rotary switch;

12. Check if there is a tachograph disc inserted (optional);

13. Start the diesel engine:



- Turn the *ignition key* fully clockwise and release it as soon as the engine is running:
  - The diesel engine can only be started after all systems are started;

14. Check the instruments when the diesel engine is running.

#### 4.4.2. CHECKLIST: Start diesel engine in cold environment

**CAUTION!**

The issues in this checklist are just briefly explained.



For further information, procedures and safety regulations, see the related paragraph.

1. Check if the fuel and engine specifications are in accordance with the prescribed standards of the diesel engine manufacturer, associated with low temperatures;
2. Check the anti-freeze concentration of the coolant:
  - Trucks which are equipped for cold areas, can be provided with a heater in the coolant system;
3. Check the anti-freeze concentration of the windscreen washer fluid.

#### 4.4.3. Instruments: Turn the truck on ignition

**CHECK / TEST!**



Check the control panel lighting of the truck every day before driving off and at the annual maintenance.

**CHECK / TEST!**



Before starting the diesel engine, always check if the right lights and signals become active after turning the ignition on.

If any defect or malfunction occurs, it is **NOT ALLOWED** to start the diesel engine!

#### Indicators



After turning on the ignition, all indicators light up once.

Check if there are no defect indicators.

After the systems starts up, the following indicators become active:



- Indicator *charging current batteries*;



- Indicator *parking brake* (if activated):
  - Flashes (1 Hz) as long as the system has not reached its working pressure;



- *Warning light* (cause: no air pressure in circuit 2).

### Main screen

While starting up, the *main screen* shows the *start-up screen* with the Spierings Mobile Cranes logo (see *Picture 4-2*).



Picture 4-2

After starting up, the following symbols on the main screen become active:



- The symbol *oil pressure low* flashes (1 Hz);
- The symbol *engine management* (on and off);
- The symbol *steering system* (on and off);
- The symbol *power-assisted front steering axles* flashes (1 Hz);
- The symbols *no air pressure in circuit 1* and *2* flash (1 Hz);
- The symbol *transfer case* (depending on state and setting).

### Display control panel gear box

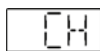

After turning on the ignition, the gear box will carry out a self test.

After this test, the *display gear box* shows the result and/or the chosen gear.

### 4.4.4. Instruments: After starting the diesel engine

#### CHECK / TEST!



**Before driving always check if the right lights and symbols become active. If any defect or malfunction occurs, it is NOT ALLOWED to drive!**

### Indicators



Shortly after starting the diesel engine, the following indicators and symbols are active:



- Indicator *parking brake* (if activated):
  - Flashes (1 Hz) as long as the system has not reached its working pressure.



### Main screen

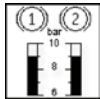

- The symbol *no air pressure in circuit 2* flashes (1 Hz);
- The symbol *transfer case* (depending on state and setting);
- The *air pressure in circuit 1 and 2* is built up:
  - Normally spoken the air pressure varies between 8 and 10 bar;
  - To be able to drive away, the air pressure must be at least 5 bar.
 When the air pressure is lower than 5 bar, the parking brake cannot be released.

### 4.4.5. Instruments: During driving



#### CAUTION!

**Stop the vehicle directly when a defect or malfunction occurs!**

Keep a close eye on the instruments during the tour.

For more information, see § 3.9. *Control panel*.



- The *warning light* and/or *error message light (and buzzer)* may not be active;



- The temperature gauge of the coolant:
  - The red indicator may not be active; if it is, then the temperature of the coolant is higher than or equal to 110°C;



- The symbol *coolant level* on the *main screen* may not be active;



- The symbols *oil level* on the *main screen* may not be active:

- Check if there is no oil leaking;



- The symbol *oil pressure* on the *main screen* may not be active;



- The symbols *air pressure circuit 1 and 2* on the *main screen* may not be active (at a moving vehicle):

- Check if there is hydraulic oil leaking;



- Air pressure gauge circuit 1 and 2 on the main screen must indicate 8 to 10 bar:

- Check if there is no air leaking;



- Fuel gauge:

- Check if there is enough fuel in the tank and if there is no fuel leaking;



- The symbol *EAS malfunction* may not be active;



- The *AdBlue level indicator* on the *main screen*:

- Check if there is sufficient AdBlue in the tank and if there is no AdBlue leaking.

#### 4.5. Switching gears

**CAUTION!**

 It is not permitted to leave the driver's position when the engine is running and the acceleration is enabled!

**CAUTION!**

 Switching gears is only possible on a running diesel engine.

The truck is provided with an automated mechanical gear box.

The gear box operates the coupling and chooses the right gear fully automatically.

Manual operation is also possible.

The gear box chooses the right gear depending on the following factors:

- Driving resistance;
- Mass of the vehicle;
- State of the accelerator;
- Vehicle speed;
- Diesel engine speed.

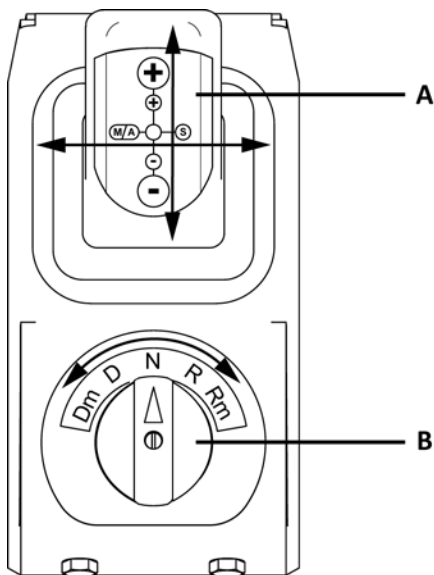

Picture 4-3

**Gear lever** (see *Picture 4-3, point A*):

- M/A: Switching between Automatic and Manual mode;
- S: No function;
- + (small) : Select one gear up;
- + (large): Select two gears up;
- - (small): Select one gear down;
- - (large): Select two gears down.

**Rotary switch** (see *Picture 4-3, point B*):

- N: *Neutral*;
- D: *Forward / Drive*: drive forward;
- R: *Backward / Reverse*: drive reverse;
- Dm: *Manoeuvre forward*;
- Rm: *Manoeuvre backwards*.

When manoeuvring in *Dm* and *Rm* mode, the gear box is not switching gears.

The gear box has 16 forward gears and 2 reverse gears.

The *display gear box* on the control panel shows the current gear and state.

#### 4.5.1. Gear lever

The *gear lever A* (*Picture 4-3*) is operated by pushing it in a certain direction and then releasing it again:

- The gear lever springs back to the centre position.

##### Switch to automatic mode



- By pushing the *gear lever* once to the left in *manual mode* and releasing it again, the *automatic mode* is enabled;
- Switching is only possible when *D* or *R* is active:  
In *neutral position* there will be no switching between manual or automatic mode.

##### Switch to manual mode



- By pushing the *gear lever* once to the left in *automatic mode* and releasing it again, the *manual mode* is enabled;

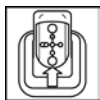

- By pushing the gear lever once forward (+) in automatic mode and releasing it again:
  - The gear box selects also (if possible) one gear up;



- By pushing the gear lever once backward (-) in automatic mode and releasing it again:
  - The gear box selects also (if possible) one gear down.

##### Switch between gears in manual mode

For more information, see § 4.5.4. *Manual mode*.

#### 4.5.2. Rotary switch

Rotary switch B (Picture 4-3) is used to switch the gear box to another transport mode.

Switching gears is only possible on a running diesel engine.

The choice of acceleration is determined by the software of the gear box, taking into account the actual speed (standstill or moving) and to which gear must be switched .



The choice, which is made by the electric system, is shown on the *display gear box* (§ 3.9.3. Display gear box).

##### CAUTION!



The position of the rotary switch and the actual enabled position of the gear box may differ from each other!

The position which is shown on the *display gear box* is leading!



##### Rotary switch on position N: neutral

Use this position to enable the gear box to *neutral*:

- In the *neutral position* there is no acceleration enabled;
- When switched from *D* or *R* to *N*, the gear box always responds immediately:
  - The *neutral position* has the highest priority.

##### CAUTION!

The engine brake becomes inactive when driving there is a switch to the *neutral position (N)*.



If the diesel engine fails (e.g. lack of fuel), there may not be switched.

The gear box automatically returns to the *neutral position (N)*.

The engine brake and the steering pump will also fail in this situation.



##### Rotary switch on position D: forward / drive

Use this position to switch the gear box to *forward / drive*:

- When switched from *N* to *D*, the gear box will choose a suitable acceleration (if the diesel engine is running at idle speed or the vehicle is moving);
- When switched from *R(M)* to *D*, the gear box will only switch if the diesel engine is running and the vehicle is not moving. When the vehicle is moving, then the gear box will switch to *N*;
- After starting the diesel engine, it will run at idle speed. The electrical system chooses and switches to a suitable acceleration to drive away;
- After switching to *D* on a moving vehicle, the electrical system will choose a gear, which matches the current speed.





#### Rotary switch on position R: backward / reverse

Use this position to switch the gear box to *backward / reverse*:

- After starting the diesel engine, it will run at idle speed. The electrical system chooses and switches to a suitable acceleration to drive away backwards;
- When switched from *N* to *R*, the gear box will only switch if the diesel engine runs at idle speed and the vehicle is not moving.  
When the vehicle is moving, then the gear box will not switch;
- When switched from *D(M)* to *R*, the gear box will only switch if the diesel engine runs at idle speed and the vehicle is not moving.  
When the vehicle is moving, then the gear box will switch to *N*.



#### Rotary switch on position DM: manoeuvre forward / drive

Use this position to switch the gear box to *manoeuvre forward / drive*:

- When switched to *DM*, the gear box will only switch if the diesel engine runs at idle speed and the vehicle is not moving.  
When the vehicle is moving, then the gear box will not switch.



#### Rotary switch on position RM: manoeuvre backward / reverse

Use this position to switch the gear box to *manoeuvre backward / reverse*:

- When switched to *RM*, the gear box will only switch if the diesel engine runs at idle speed and the vehicle is not moving.  
When the vehicle is moving, then the gear box will not switch.

#### CAUTION!



In both *forward / drive (D)*, *backward / reverse (R)*, *manoeuvre forward / drive (DM)* and *manoeuvre backward / reverse (RM)* the vehicle can roll away (even without operating the accelerator)!

#### 4.5.3. Automatic mode

After starting the diesel engine (§ 4.4. *Start diesel engine truck*) the gear box will be in the *automatic mode* as default.



If the gear box is in *automatic mode*, the *display gear box* shows all horizontal beams and arrow heads (§ 3.9.3. *Display gear box*).



By pushing the gear lever to the left, there can be switched between *automatic* and *manual mode*.

In automatic mode, the gear box can also manually be switched to higher and lower gear by means of the gear lever.



By pushing the gear lever forward (+) or backward (-) over a short distance, one higher gear or one lower gear can be chosen. This should be in the safe range of engine speed etc. Otherwise the gear box will not perform the specified command.

By pushing the gear lever forward (+) or backward (-) over a maximum distance, two higher gears or two lower gears can be chosen.

#### **Accelerating**

When accelerating, the gear box will automatically switch. When speeding up quickly, the gear box will sooner skip gears and the fuel consumption will be less economic.

#### **Braking**

After braking and continue driving at a lower speed, the gear box determines the correct gear based on speed, engine speed and the position of the accelerator (§ 4.8. Brakes).

The vehicle can be stopped in any gear. At a brief stop (such as at a traffic light), the acceleration remains switched on.

#### **4.5.4. Manual mode**

After starting the diesel engine (§ 4.4. Start diesel engine truck) the gear box will be in the *automatic mode* as default.



By pushing the gear lever to the left, there can be switched between *automatic* and *manual mode*.



If the gear box is in *automatic mode*, the *display gear box* shows the number of the current gear. The horizontal beams and arrow heads are (partly) disappeared.



By pushing the gear lever forward (+) or backward (-) over a short distance, one higher gear or one lower gear can be chosen. This should be in the safe range of engine speed etc. Otherwise the gear box will not perform the specified command.

By pushing the gear lever forward (+) or backward (-) over a maximum distance, two higher gears or two lower gears can be chosen.

The *display gear box* advises the ideal gear by means of beams and arrow heads.  
Each bar represents one gear (see *Table 4-1*).

**Examples**

	<p>Gear box in 4<sup>th</sup> gear without recommendation. The number indicates the current gear (1 to 16).</p>
	<p>Gear box in 5<sup>th</sup> gear with recommendation to switch to the 6<sup>th</sup> gear.</p>
	<p>Gear box in 6<sup>th</sup> gear with recommendation to switch back to the 3<sup>rd</sup> gear.</p>

Table 4-1

**INFORMATION!**

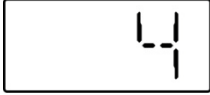
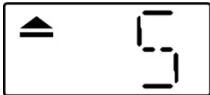
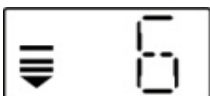

When in *automatic mode* the gear box chooses the optimum gear based on fuel consumption and power.

It is therefore not recommended to use the manual mode frequently.

**4.6. Driving off**

**CONDITIONS**



- § 4.3.1. CHECKLIST: *Before driving on public roads* must be carried out;
- § 4.4. *Start diesel engine truck* must be carried out;
- To be able to drive away, the air pressure must be at least 5 bar. When the air pressure is lower than 5 bar, the parking brake cannot be released.



1. Push and keep the brake pedal pushed in;



2. Switch the gear box to *forward (D)* by using the rotary switch;



**CAUTION!**

The vehicle must never move in the opposite direction of the chosen gear.



2. Release the parking brake:  
- Pull the lever and move it forwards;



3. Release the brake pedal and push the accelerator gradually:  
- The vehicle starts to move forwards.

On a flat road the gear box will switch fully automatically. The gear box chooses the right gear for acceleration. If desired, the gear box can be operated manually (however, this is not recommended).

#### 4.7. Driving backwards

##### CONDITIONS



- § 4.3.1. **CHECKLIST: Before driving on public roads must be carried out;**
- § 4.4. **Start diesel engine truck must be carried out;**
- **To be able to drive away, the air pressure must be at least 5 bar. When the air pressure is lower than 5 bar, the parking brake can not be released.**



1. Push and keep the brake pedal pushed in;



2. Check if the vehicle fully stands still and if the engine runs on idle speed;

3. Switch the gear box from *neutral (N)* to *backward (R)* by using the rotary switch:



- The *display gear box* shows *RL (Reverse Low)*;

4. Using the wind mirrors and the (optional) reverse drive camera, check if there are no persons or objects behind the vehicle;



5. Release the brake pedal and push the accelerator gradually:

- The vehicle starts to move backwards.



When in automatic mode the gear box (if needed) will switch automatically between *RL (Reverse Low)* and *RH (Reverse High)*.



If desired, the gear box can be switched manually by moving the gear lever forwards (+) or backwards(-).



When the vehicle is moving and the rotary switch is switched to backward (R), the gear box automatically switches to *neutral (N)*:



- The *display gear box* shows *N*.

## 4.8. Brakes

The truck is provided with four braking systems:

- Service brake (§ 4.8.1. *Service brake*);
- Parking brake (§ 4.8.2. *Parking brake*);
- Engine brake (§ 4.8.3. *Engine brake*);
- Retarder (§ 4.8.4. *Retarder*).

### 4.8.1. Service brake



The service brake is operated by the brake pedal and works pneumatically:

- When the service brake is operated, the brake lights will light up;
- When a trailer is attached, also the trailer brake lights will light up.



The current air pressure is shown on the *main screen* (§ 3.9.2.1. *Main screen: General screen*).



When the air pressure drops below 5.5 bar, the *buzzer* and *error message light* on the control panel become active:

- **Stop the vehicle immediately!**



If the air pressure drops further, at some point the parking brake will become active:

- The indicator *status braking system* on the control panel becomes active.

#### 4.8.1.1. Service brake at trailer connection



If the truck is equipped with an optional *trailer connector*, the service brakes of the attached trailer will also be active by pushing the brake pedal:

- When operating the service brake, the brake lights of the trailer will also light up.

For more information, see § 4.14. *Driving with a trailer*.

#### 4.8.2. Parking brake

For more information, see § 4.9.2. *Parking*.

 **CAUTION!**  
**ALWAYS activate the parking brake after parking the vehicle!**

 **CAUTION!**  
**Check if the parking brake lever is locked correctly to prevent from rolling away.**



The parking brake is activated when the parking brake lever is moved backwards:

- This will cause the spring brake boosters to vent and the parking brake to be active;



- The indicator *status brake system* on the control panel becomes active.

In the most backward position, the parking brake lever will be locked and the parking brake remains enabled.



The parking brake will be released by pulling out the parking brake lever and to move it forward.



The indicator *status braking system* on the control panel disappears.

 **CAUTION!**  
**The vehicle must never move in the opposite direction of the chosen gear.**

#### 4.8.2.1. Parking brake at trailer connection



If the truck is equipped with an optional *trailer connector*, the parking brake lever has a *test position*.



If a trailer with air brakes is attached, the brakes are activated after operating the parking brake of the truck.

The regular braking system of the trailer is used by continuously pressed air. However, it is possible that the braking capacity of the trailer reduces or even completely disappears because of losses of pressed air.



To test whether the trailer combination remains unmoved on the parking brake of the truck only, the parking brake lever must be pulled out of the parking position and moved further to the backward position.

The trailer brakes are hereby released, so only the parking brakes of the truck are activated.



As soon as the parking brake lever is moved back to its parking position, there will be air pressure on the braking system of the trailer again.

For more information, see § 4.14. *Driving with a trailer*.

#### CAUTION!



Before leaving the driving position, always check (by putting away the truck-trailer combination on a hill) if the combination remains unmoved when only the parking brakes of the truck are activated.

#### 4.8.2.2. Parking brake as an emergency brake

#### CAUTION!



Move the parking brake lever dosed backwards when used while driving.

If the air pressure for the service brake is too low, the parking brake can be used to slow down the moving vehicle.



Move the parking brake lever dosed backwards:

- Once the parking brake has been operated, this brake cannot be released till the air pressure is restored again.

#### 4.8.3. Engine brake

Using the engine brake is especially useful at prolonged braking, for instance at high speed on a flat road or at downhill driving. As a result, the wear of the service brake will be reduced.



By pressing the foot switch on the floor of the truck cab, the engine brake is activated.

The engine brake shuts off the fuel supply. Also the exhaust will be closed by means of a valve.

The biggest braking performance will be in the range of 1,500 up to 2,100 rpm.

The braking effect decreases as the engine speed drops.



**CAUTION!**

**Exceeding of the authorised engine speed may result in serious engine damage.**

As long as the foot switch is pressed, the engine brake is performing except in the following situations.

The engine brake is automatically turned off if the engine speed drops below 800 rpm or at a vehicle speed lower than 3 kph (1.9 mph).

While operating the engine brake, the brake lights are not illuminating.

It is not possible to disable the engine by means of the engine brake.

**CAUTION!**

**Keep distance when using the engine brake during a downhill drive.**



**If the gear box switches, the effectiveness of the engine brake can temporarily be reduced and the vehicle may speed up shortly.**



#### 4.8.4. Retarder

For slowing down at high speeds and at long downhill driving, the use of a *retarder* is conveniently. Use of the retarder reduced wear of the service brake.

The retarder is operated by the right control lever on the steering column (*Picture 4-4*).

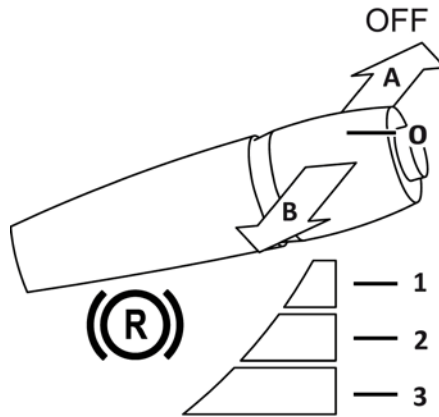

Picture 4-4

The lever has five positions:

- OFF: Disable Bremsomat (spring returned to 0);
- 0 : *Retarder off* (centre position);
- 1 : Approx. 33% of the maximum braking torque;
- 2 : Approx. 66% of the maximum braking torque;
- 3 : Maximum braking torque.

##### Activating retarder



By moving the right control lever from its centre position to position 1 to 3 (*Picture 4-4, point B*), the deceleration of the retarder can be set:

- Always enable evenly (with short intervals) between the *positions 1, 2 and 3* to build the braking performance gradually;
- Disable the *retarder (position 0)* by means of a single operation without short intervals;
- The final deceleration depends on the vehicle speed.



When the *retarder* is enabled, on the § 3.9.2.1. *Main screen: General screen* the symbol *retarder* is active:

- When operating the *retarder (positions 3 to 5)*, the brake lights will illuminate.



If the retarder is enabled, it is not possible to accelerate:

- First enable the *retarder* by moving the right control lever to its centre position (0).

##### INFORMATION!



For long downhill driving, the use of *position 2* (66% of the maximum braking torque) of the right control lever is advised.

At excessive use of the retarder, the oil and coolant temperature may increase significantly. When the coolant temperature is too high, the control of the gear box will switch back the retarder automatically. The braking force then decreases.



Keep an eye on the cooling water sensor on the control panel when the retarder is used excessively.



The *orange indicator*, the *red error message light* and the *buzzer* will become active if the coolant temperature is higher than or equal to 110°C.



Measures to prevent high oil and coolant temperature:

- Switch the *gear box* one or more gears lower;
- Switch the *retarder* to a lower position (*position 1 or 2*);
- Turn off the *retarder* completely.

If these measures do not help to lower the oil temperature, the *retarder* will be automatically turned off.

#### 4.8.5. Bremsomat

Using the *bremsomat*, the *retarder* is set to a maximum speed. The speed will remain constant during downhill driving.

##### Activating the bremsomat



The *bremsomat* is activated and set to the current speed by pressing the right control lever on the steering column in *longitudinal direction A* (see *Picture 4-5*).

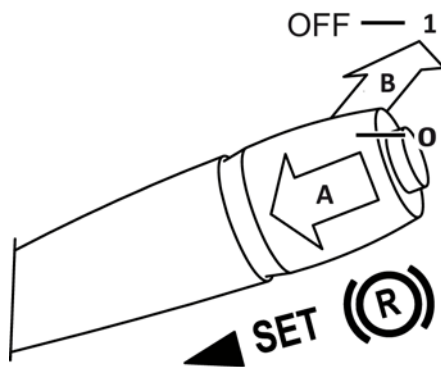

Picture 4-5

##### Disable the bremsomat



Push the right control lever in the *transversal direction B* (see *Picture 4-5*) to disable the *bremsomat*.

## 4.9. Stop

### 4.9.1. Turn off diesel engine



**CAUTION!**

Only turn off the diesel engine of the truck if the vehicle fully stands still.



1. Activate the parking brake:
  - Move the parking brake lever backwards till it is locked;



2. Enable the gear box by moving the rotary switch to the *neutral position (N)*:



- The *display gear box* shows *N*;

**CAUTION!**

Always activate the parking brake before turning off the ignition of the truck.



The gear box is automatically enabled to the *neutral position (N)*, whereby the vehicle may roll unexpectedly.



3. Turn the *ignition key* fully counterclockwise to turn off the engine:
  - Let the engine run for a few minutes at idle speed when the engine has been used under a heavy load for an extended period of time, to prevent overheating of the turbo and coolant;



4. Remove the *ignition key truck*.

### 4.9.2. Parking



1. Activate the parking brake:
  - Move the parking brake lever backwards till it is locked;



2. Enable the gear box by moving the rotary switch to the *neutral position (N)*:



- The *display gear box* shows *N*;



3. Switch off the *main switch truck* on the control panel (§ 3.9. Control panel).

### Uphill parking

Extra measure for uphill parking:

4. Block the wheels by using the outriggers to prevent the vehicle from rolling;
5. When uphill parking the truck-trailer combination (if trailer connector is used), before leaving the driver's position always check if the combination remains unmoved while only using the parking brake of the truck.

For more information, see § 4.8.2.1. *Parking brake at trailer connection.*

### 4.9.3. Long-term parking / garaging

If the vehicle is parked or stored for a long time during winter, there is a risk of freezing water which has been accumulated in the tower of the crane.

Therefore put the vehicle in uphill position so the water can flow away:

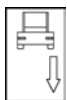

1. Enable switch *release axle height adjustment*.
  - The axle height adjustment becomes active;
2. Operate switch *axles 1 and 2 up / down* to retract the front axles;
3. Operate switch *axles left-hand rear up / down* and switch *axles right-hand rear up / down* to push out the rear axles;
4. Check if all wheels of the vehicle are standing on the ground.

For more information, see § 4.13.2. *Axle height adjustment.*

## 4.10. Speed regulators

### 4.10.1. Cruise control

The *cruise control* allows driving at a constant vehicle speed without using the accelerator.

*Cruise control* is operated by the *right control lever* on the steering column (*Picture 4-6*):

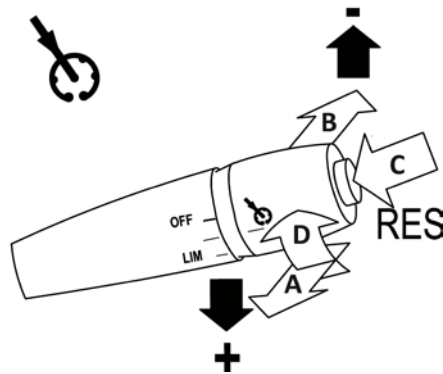

Picture 4-6

- A. + : Enable *cruise control*;
  - Speed up (at 0.5 kph (0.3 mph)) (spring returned to centre position);
- B. -- : Enable *cruise control*;
  - Speed down (at 0.5 kph (0.3 mph)) (spring returned to centre position);
- C. RES: Enable *cruise control* with use of last set value;
- D. OFF: Disable *cruise control* (spring returned to centre position).

#### Activate cruise control

Activating *cruise control* can be carried out in two different ways (*Picture 4-6*):

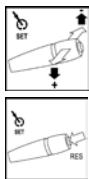

1. By moving the right control lever shortly in *direction A or B*:
  - The current vehicle speed is stored till the ignition key is removed;
2. By pressing *RES* on the end of the right control lever (*direction C*):
  - If the *cruise control* is used since the ignition is turned on, the speed will go to the last set value;

The *cruise control* can only be activated when the vehicle speed is higher than 30 kph (18.7 mph).

#### Adjust cruise control



If the *cruise control* is activated, the speed can be increased or reduced by moving the right control lever in the *direction of A or B* (see *Picture 4-6*):

- One short movement: the speed increases/reduces with 0.5 kph (0.3 mph);
- One longer movement: the speed increases/reduces gradually in steps of 0.5 kph (0.3 mph).

**Disable cruise control**



The *cruise control* will be disabled by turning the end of the right control lever to position OFF (Picture 4-6 , direction D).

Conditions of which the *cruise control* shuts off are shown in Table 4-2.

		Result		
		Enables cruise control	Prevents enabling cruise control	Disables cruise control
<b>Operated</b>	Right control lever to + or - (A or B)	X		
	After pressing RES (C)	X		
	Speed out of range (< 30 kph (18.7 mph))		X	X
	When using service brake		X	X
	When using parking brake		X	X
	When using engine brake		X	X
	When using retarder		X	X
	When using variable speed limitation device		X	X
	Right control lever to position OFF (D)		X	X

Table 4-2

Not only at braking, but also when the deceleration is more than 1.4 m/s<sup>2</sup> (for instance at a collision), the *cruise control* will be disabled .

**4.10.2. Variable speed limitation device**

The *variable speed limitation device* allows to limit the vehicle speed to a desired speed. The *variable speed limitation device* is operated by the right control lever at the steering column (Picture 4-7).

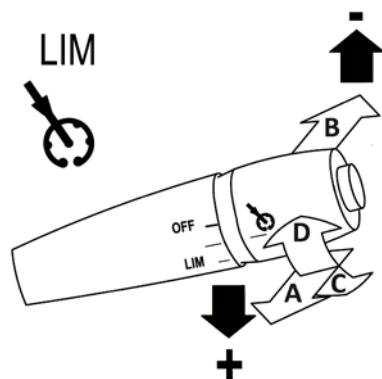

Picture 4-7

- A. + : Increases speed (with 0.5 kph (0.3 mph)) (spring returned to centre position);
- B. -- : Reduces speed (with 0.5 kph (0.3 mph)) (spring returned to centre position);
- C. LIM: Enables *variable speed limitation device* (spring returned to centre position);
- D. OFF: Disables *variable speed limitation device* (spring returned to centre position).

**Activate variable speed limitation device**

Activate the *variable speed limitation device* as follows (Picture 4-7).



Turn the end of the control lever in the direction of *LIM* (direction C):

- The current speed is stored till the ignition is turned off;
- The vehicle speed is limited to the stored speed.

The *variable speed limitation device* can only be activated if the vehicle speed is higher than 30 kph (18.7 mph).

**Adjust variable speed limitation device**



If the *variable speed limitation device* is activated, the speed can be increased or reduces by moving the right control lever in *direction A* or *B*:

- One short movement: the speed increases/reduces with 0.5 kph (0.3 mph);
- One longer movement: the speed increases/reduces gradually in steps of 0.5 kph (0.3 mph).

If the accelerator is pressed in *kick-down* while the *variable speed limitation device* is active, the set speed can be exceeded (for instance for an overtaking manoeuvre).

**Disable variable speed limitation device**



Disable the *variable speed limitation device* by means of turning the end of the right control lever to position *OFF* (direction D).

Conditions of which the *variable speed limitation device* enables/disables (Table 4-3).

		Result		
		Enables variable speed limitation device	Prevents enabling variable speed limitation device	Disables variable speed limitation device
Operated	Right control lever to position <i>LIM</i> (C)	X		
	Speed out of range (< 30 kph (18.7 mph))		X	X
	Right control lever to position <i>OFF</i> (D)		X	X

Table 4-3

#### 4.10.3. Engine speed control (ESC)

The *engine speed control (ESC)* allows the diesel engine to run a constantly increased engine speed. This feature is desired when outriggering the vehicle.

The *engine speed control* is operated by the right control lever on the steering column (*Picture 4-8*).

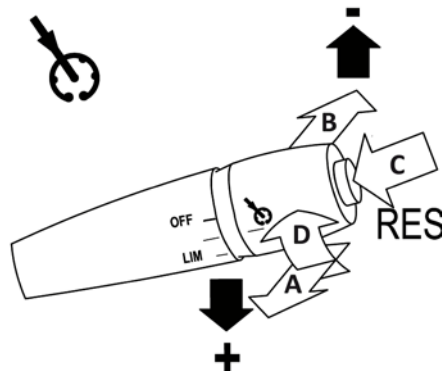

Picture 4-8

- A. + : Enable *engine speed control*;  
- Increases engine speed (with 50 rpm) (spring returned to centre position);
- B. -- : Enable *engine speed control*;  
- Reduces engine speed (with 50 rpm) (spring returned to centre position);
- C. RES: Enable *engine speed control* (with 1,260 rpm)( spring returned);
- D. OFF: Disable *engine speed control* (spring returned to centre position).

#### Activate engine speed control

Activate *engine speed control* can be done as follows (*Picture 4-8*):



1. By pressing *RES* at the end of the right control lever (*direction C*):  
- The engine speed will go to 1,260 rpm;



2. By moving the right control lever shortly in *direction A* or *B*:  
- The current engine speed is stored till the ignition is turned off.



The *engine speed control* can only be activated when the automatic gear box is in *neutral (N)* position.

#### Adjust engine speed control



If the *engine speed control* is activated, the engine speed can be increased/reduced by moving the right control lever in *direction A* or *B*:

- One short movement: the engine speed increases/reduces with 50 rpm;
- One longer movement: the speed increases/reduces gradually in steps of 50 rpm.



### Disable engine speed control

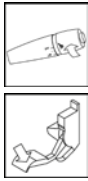

Disable the *engine speed control* can be done as follows:

1. By turning the end of the control lever to *position OFF (direction D)* (see *Picture 4-8, point 1*);
2. By operating the accelerator.

Conditions of which the *engine speed control* enables/disables are shown in *Table 4-4*.

		Result		
		Enables engine speed control	Prevents enabling engine speed control	Disables engine speed control
<b>Operated</b>	Right control lever to + or - ( <i>A or B</i> )	X		X
	After pressing <i>RES (C)</i>	X		X
	Right control lever to position <i>OFF (D)</i>		X	X
	Speed out of range (> 0)		X	X
	When using service brake		X	X
	When using engine brake		X	X

*Table 4-4*

### 4.11. Uphill and downhill driving

**CAUTION!**

**While uphill or downhill driving, take into account that the automatic coupling can be opened unexpectedly.**

If the accelerator is released (by a possible traffic situation) while uphill or downhill driving, it may occur that the automatic gear box will switch down to an acceleration gear.

Shortly before the vehicle stops, the gear box will automatically disengage the gear ratio.

This can cause the vehicle to move backwards or to speed up.

If the accelerator is operated again, it will not directly result in pulling capacity because first the coupling must be engaged.

- Use the *service brake* while uphill driving (after opening the coupling);
- While uphill driving, take into account the reduction of the braking power:
  - In this situation operate the service break to a greater extent;
- While uphill driving, take into account a possible reduced and delayed pulling capacity.

## 4.12. Refuelling

### 4.12.1. Refuelling diesel

#### CAUTION!



Use only EN 590 diesel fuel to avoid damage to the fuel system.

Never completely empty the fuel tank to prevent the fuel system from venting.



#### INFORMATION!

For more information, see § 10.1. *Specifications diesel engine truck.*



#### FIRE HAZARD!

Smoking or open flames prohibited!

The fuel tank is built into the chassis of the truck.

The filler neck is located on the right-hand rear of the truck and can be reached by opening the cover (see *Picture 4-9*).



Picture 4-9

The filler neck is provided with a lock. When using key *fuel tank* the filler neck will be locked.

For refuelling the next steps must be carried out:

1. Open the cover on the crane platform;
2. Use key *fuel tank* to open the lock (turn the key clockwise);
3. Turn the filler cap counterclockwise and remove it;
4. Fill the tank with diesel (see § 10.1. *Specifications diesel engine truck*);
5. Replace the filler cap and turn it clockwise;
6. Close the cover on the crane platform.



### Check fuel level



If the ignition of the truck is turned on, the fuel gauge on the control panel shows the current fuel level by means of an analogue pointer.



If the fuel level reaches a certain level, the orange indicator becomes active:

- There is still about 50 litres of fuel in the tank;
- Refill the fuel tank as soon as possible.

### 4.12.2. Refuelling AdBlue

#### **CORROSIVE SUBSTANCES!**

**AdBlue must meet the specifications according to DIN 70070.**

**Safety regulations AdBlue:**

- Avoid physical contact;
- After skin contact: rinse with plenty of water;
- After eye contact: rinse with plenty of water for at least 15 minutes and call for medical help;
- In case of ingestion: rinse mouth with plenty of water, do NOT induce vomiting;
- After inhalation: breathe fresh air, rest. Call for medical help;
- Use in ventilated areas.



#### **INFORMATION!**

For more information, see § 10.1. *Specifications diesel engine truck.*

**AdBlue is harmless to the environment and non-toxic.**

**Spilled AdBlue can be removed with clean water.**

**Once the spilled AdBlue is dried up, it can leave behind a white saturation.**

**This white saturation can also be removed with water.**



The AdBlue-tank is built into the chassis of the truck at the co-driver's side and has a capacity of approx. 75 litres. The filler neck is provided with a blue screw cap. By removing the cover on the right-hand side in the crane platform, the filler neck can be reached (Picture 4-10).



Picture 4-10

1. Open the cover on the crane platform;
2. Turn the blue screw cap counterclockwise and remove it;
3. Refill the tank with AdBlue and support the refuelling nozzle to prevent the plastic filling pipe from breaking off;
4. Replace the blue screw cap and turn it clockwise;
5. Close the cover on the crane platform.

### Check AdBlue level

The *AdBlue* level is shown on the *main screen* by means of a *level indicator* (Picture 4-11, point 1).

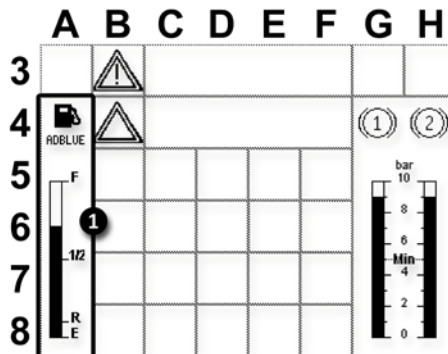

Picture 4-11

- F: *AdBlue* level maximum (Full);
- ½ : *AdBlue* level at approx. half of the tank capacity;
- R: *AdBlue* level at approx. 10% of the tank capacity (Reserve):  
Refill *AdBlue* as soon as possible to prevent from reducing engine capacity;
- E: There is no more *AdBlue* (Empy):  
Refill *AdBlue* as soon as possible, the engine capacity is limited to 60%.



#### INFORMATION!

The *AdBlue* consumption is approx. 1 litre on 50 litres of fuel.



If the fluid level reaches approx. 10% of the tank capacity (Picture 4-11, point R), the warning *AdBlue level low* is shown:

- On the *main screen*, symbol *AdBlue level* is flashing (1 Hz).



If the fluid level is dropped to *point E* (Picture 4-11), the EAS system will be disabled:

- On the *main screen* symbol *EAS malfunction* becomes active, simultaneously with the yellow *warning light* on the control panel;
- When this error message occurs, the available engine capacity will be limited to 60% of the maximum torque.

There will always be a small amount of *AdBlue* in the tank (approx. 4 litres) to prevent the EAS system from sucking air.



If the EAS system cannot adjust the emission within the regulating emission standard, the maximum engine capacity will also be limited to approx. 60%:

- On the *main screen* symbol *EAS malfunction* becomes active, simultaneously with the yellow *warning light* on the control panel;
- On the *Main screen: Information screen* the error codes can be read;
- Solve the problem as soon as possible. Contact Spierings Mobile Cranes.

Depending on the malfunction, it can take up to 50 hrs. for the engine capacity to reduce.

### AdBlue and the law

According to the EG directive, the manufacturer is obliged to include the following text in the user manual.

*“In order to meet the emission certificate of the engine, AdBlue is used as a reagent.*

*That is why AdBlue is required.*

*If no AdBlue is consumed, while this is necessary to comply with the emission conditions, then this may be a criminal offence.*

*This may cause any favourable conditions (e.g. subsidy schedules or low rate engine vehicle tax), which were obtained at the purchase or use of this vehicle (in the country of registration or use) to be invalidated.”*

## 4.13. Off-the-road driving

### CAUTION!



The driver of the truck must meet the same regulations as when driving on public roads.

### 4.13.1. Axle load

### CAUTION!

Make sure that while driving all wheels are making contact with the ground.

All tyres must be curved (with the exception of possible retracted axles for the benefit of a steering program).



This is necessary for not exceeding the maximum permissible axle load.

An exception to the above mentioned warning is the use of a steering program, in which axle 3 can be retracted.

Take particular care when (see *Picture 4-12* on the following page):

- Uphill or downhill driving;
- Driving in or out of a construction site;
- Driving over obstacles (for example thresholds, embankments, beams, rails and pits);
- Driving in extremely rough terrain;
- Driving in terrain with rocks, stones, concrete and debris.

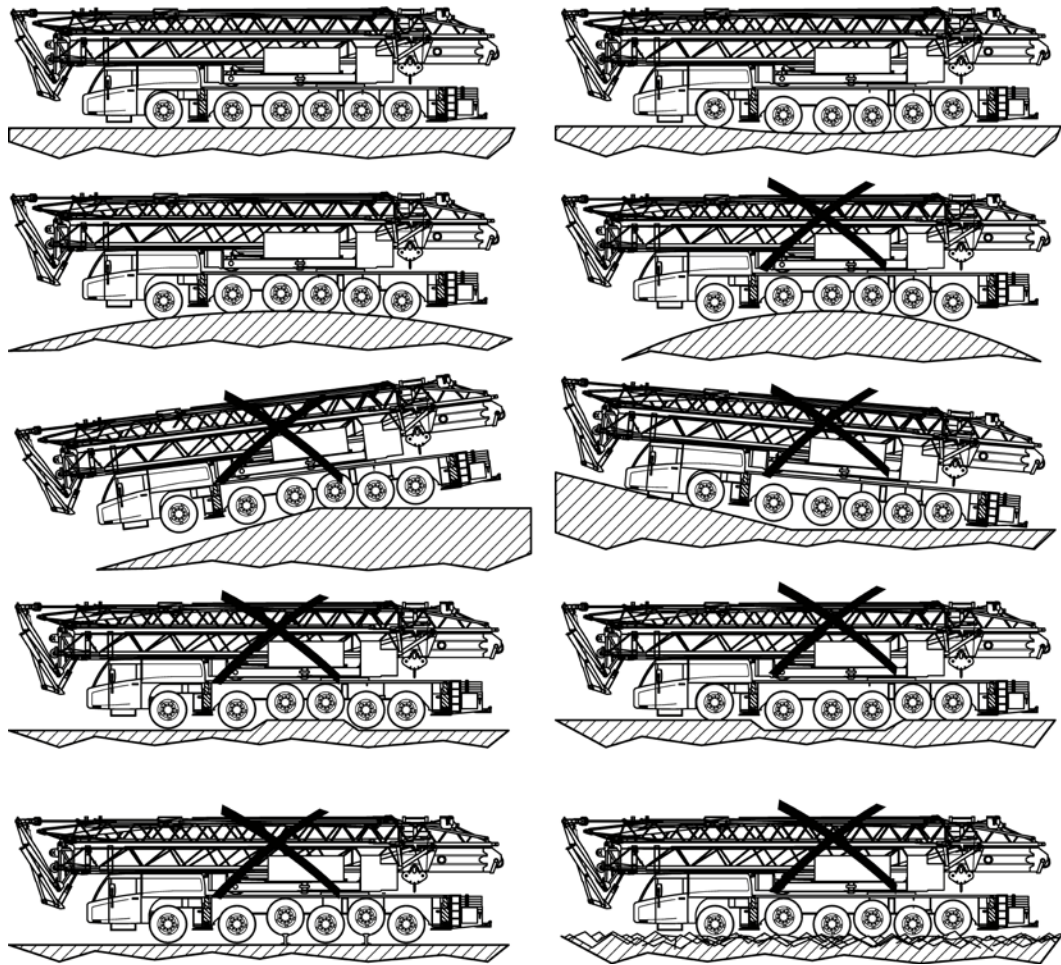

Picture 4-12

#### 4.13.2. Axle height adjustment

**CAUTION!**



Check if there are no persons on or around the truck in order to prevent dangerous situations.

**CAUTION!**



Make sure that while driving all wheels are making contact with the ground.

All tyres must be curved (with the exception of possible retracted axles for the benefit of a steering program). This is necessary for not exceeding the maximum permissible axle load.

The axles of the truck are connected to the chassis by means of hydraulic cylinders.

Using the *axle height adjustment* it is possible to control the hydraulic cylinders for adjusting the axle height when sitting in the truck cab. This feature is applicable when outriggering or switching to off-the-road mode when driving in rough terrain.

It is also possible to place the vehicle horizontal when the vehicle stands on a hill:

- While in driving mode the axles can be retracted over a distance of approx. 60 mm;
- While in driving mode the axles can be moved out over a distance of approx. 187 mm.

Adjusting the axle height will be done in three groups:

- Axles 1 and 2 up / down;
- Axles 3, 4 and 5 left-hand rear up / down;
- Axles 3, 4 and 5 right-hand rear up / down.

There is axle load compensation within the axle groups:

- Axles 1 and 2;
- Axles 3, 4 and 5.

### Switches axle height adjustment

The *axle height adjustment* is operated by the switches on the control panel (Picture 4-13):

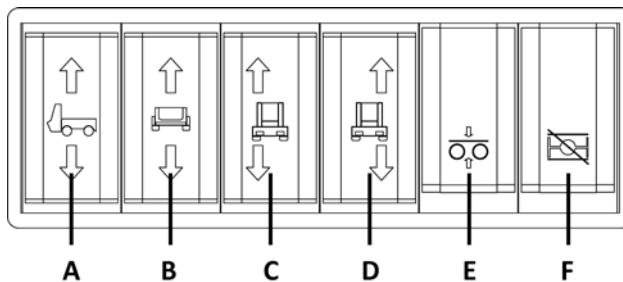

Picture 4-13

- A. Switch *all axles up / down*;
- B. Switch *axles 1 and 2 up / down*;
- C. Switch *axles left-hand rear up / down*;
- D. Switch *axles right-hand rear up / down*;
- E. Switch *levelling*;
- F. Switch *release axle height adjustment*.



For using the *axle height control*, switch *release axle height control* must be operated. If this switch is pressed, switches A to D can be operated:

- The spring load of the truck is NOT disabled.

#### 4.13.2.1. Axle blocking

##### CAUTION!



Use the function *axle blocking* only on a levelled and paved surface, so the weight of the vehicle is distributed evenly over the wheels.

##### CAUTION!



Make sure when using the *axle blocking*, that all wheels are in contact with the ground. All tyres must be curved (with the exception of possible retracted axles for the benefit of a steering program). This is necessary for not exceeding the maximum permissible axle load.

Each hydraulic cylinder is equipped with a spring accumulator, which causes the relevant axles to spring.

The total travel of the spring cylinders is 247 mm.

From the driving/levelling position, the travel is +187 mm up to – 60 mm.

The spring accumulators can be locked, causing the spring function to be disabled.

When *driving an erected tower* the suspension must be locked to allow stable transport (see § 4.16. *Driving with an erected tower*).



When the symbol *axle blocking* on the main screen appears, the spring accumulators are disabled but the suspension is not immediately locked.



Disabling the spring load happens when also the switch *outrigger control* is enabled:



- The symbol *outrigger control* on the main screen is active;

The suspension will be locked in any case the tower is not horizontally placed on the truck;

- In this situation the sensor *tower on truck* indicates that the tower is not resting on the truck anymore and as a result the suspension will be locked.

#### 4.13.2.2. Off-the-road mode



#### CAUTION!

**Check if there are no persons on or around the truck in order to prevent dangerous situations.**

To achieve the maximum ground clearance, all axles need to be fully protracted.

This is the so-called *off-the-road mode*.

Proceed as follows:



1. Enable switch *release axle height adjustment* on the control panel;



2. Keep switch *all axles down* on the control panel pressed in:
  - All axles are extended simultaneously;



- If all axles are fully extended, symbol *off-the-road mode* on the main screen becomes active;



3. Disable switch *release axle height adjustment* on the control panel:
  - The spring load of the truck is active.



#### 4.13.2.3. Levelling

**CAUTION!**

 Before driving on public roads, the vehicle must always be levelled related to the maximum transport height of 4 metres.

**CAUTION!**

 Check if there are no persons on or around the truck in order to prevent dangerous situations.

During levelling, the axles are automatically adjusted to the *on-the-road mode*.

This feature applies when the axle height is disrupted by outriggering, off-the-road mode or long-term parking.

**CONDITIONS**



- The crane must be in *transport position*;
- The truck must be standing on a flat surface;
- The outrigger control must be disabled;
- The brake pedal must NOT be used.



1. Enable switch *levelling* on the control panel:

- The axles are automatically adjusted to the *driving height*;
- When the axles are adjusted to driving height, the symbol *levelling position* on the main screen becomes active;



2. Disable switch *levelling* on the control panel.



**CAUTION!**

 Before driving, switch *levelling* must be disabled. The symbol *levelling position* may NOT be active.  
If the brake pedal is operated, levelling is NOT possible.

#### 4.13.3. Off-the-road gear

**CAUTION!**

 Switching the transfer case may only be done when the vehicle is fully standing still and de gear box is in *neutral position N*.

While driving on rough terrain or when a low vehicle speed is desired (e.g. at driving with an erected tower), the transfer case can be switched to *off-the-road gear*.

Then the transfer case has a lower gear ratio.



#### Enable off-the-road gear

Switch the transfer case to *off-the-road gear* (turtle) by using switch *transfer case on-the-road / off-the-road gear* on the control panel:



- The symbol *off-the-road gear* on the main screen becomes active.



#### Disable off-the-road gear

Switch the transfer case to *on-the-road gear* (hare) by using switch *transfer case on-the-road / off-the-road gear* on the control panel:



- The symbol *on-the-road gear* on the main screen becomes active.

### 4.13.4. Differentials

When driving off the road, the *longitudinal differential lock* and the *transversal differential lock* can be enabled, so the longitudinal and transversal differentials will be locked.

The transfer case will also act as a longitudinal differential lock.

The *differential indication screen* on the main screen shows an overview of the enabled longitudinal and transversal differential locks.

For more information, see § 3.9.2.2. *Main screen: Differential indication screen.*

#### CAUTION!



The *longitudinal and transversal differential lock* may solely be used off the road with loose ground, so NOT for driving on paved roads!

#### CAUTION!



- Enable/disable the *longitudinal and transversal differential lock* may only be done when the vehicle stands still!
- If the *longitudinal differential lock* is enabled, the road may not contain major irregularities;
- If the *transversal differential lock* is enabled, there may be NO steering;
- Check after disabling the *longitudinal and transversal differential lock* if all locked differentials are disabled.

#### 4.13.4.1. Longitudinal differential lock

##### Enable longitudinal differential lock



Enable the *longitudinal differential lock* by means of switch *longitudinal differential lock* on the control panel:

- The longitudinal differentials will be locked;
- The symbol *longitudinal differential lock* on the main screen flashes till all longitudinal differentials are enabled. After that, the symbol remains continuously active.



##### Disable longitudinal differential lock



##### CAUTION!

Disable the *longitudinal differential lock* before driving on the paved road.

Disable switch *longitudinal differential lock* on the control panel:

- The locks of the longitudinal differentials will be disabled;
- The symbol *longitudinal differential lock* on the main screen flashes till all longitudinal differentials are disabled. After that, the symbol disappears.



##### CAUTION!

Check after disabling the *longitudinal differential lock* if all longitudinal differentials are disabled.

##### Measures if the longitudinal differential lock is not automatically disabled



If the symbol *longitudinal differential lock* flashes, not all *longitudinal differential locks* are enabled/disabled:

- See § 3.9.2.2. *Main screen: Differential indication screen* for an overview of the enabled longitudinal and transversal differential locks;
- Swing shortly and slowly when driving away.

If the symbol *longitudinal differential lock* remains flashing:

- Outrigger the truck to release the wheels from the ground to eliminate any friction of the axles.

#### 4.13.4.2. Transversal differential lock

Use the *transversal differential lock* if there is still not enough grip when using *longitudinal differential locks*.

##### Enable transversal differential lock



##### CAUTION!

- Enable/disable the transversal differential lock may only be done when the vehicle is not moving, there is no steering and the *longitudinal differential lock* is already enabled;
- NEVER disable the *longitudinal differential lock* before disabling the *transversal differential lock*.



Enabling the *transversal differential lock* can be done by using switch *transversal differential lock* on the control panel. Keep the switch pressed. When releasing the switch, it will return automatically and disable the *transversal differential lock*:

- The *transversal differentials* will be locked;
- The symbol *transversal differential lock* on the main screen flashes, till all *transversal differentials* are enabled. After that, the symbol remains continuously active.



#### Disable transversal differential lock



#### CAUTION!

Disable the *transversal differential lock* before driving on the paved road.



When releasing the switch *transversal differential lock* on the control panel, the *transversal differentials* are not locked anymore:

- The locks of the transversal differentials will be disabled;
- The symbol *transversal differential lock* on the main screen flashes till all transversal differentials are disabled. After that, the symbol disappears.



#### CAUTION!

Check after disabling the *transversal differential lock* if all transversal differentials are disabled.



#### Measures if the transversal differential lock is not automatically disabled

If the symbol *transversal differential lock* flashes, not all *transversal differential locks* are enabled/disabled :

- See § 3.9.2.2. *Main screen: Differential indication screen* for an overview of the enabled longitudinal and transversal differential locks;
- Swing shortly and slowly when driving away.

If the symbol *transversal differential lock* remains flashing:

- Outrigger the truck to release the wheels from the ground to eliminate any friction of the axles.

#### 4.13.5. Manoeuvring: Steering system

Manoeuvring (also called shunting) is the accurate positioning of the vehicle.

To manoeuvre the vehicle accurate, it is equipped with an advanced steering system (the so-called *rear axle steering*), which will provide the use of four different steering programs.

These steering programs distinguish from each other by the difference in steering characteristics of the rear axle:

1. *Small turning cycle*: In this steering program an extra small turning cycle is possible;
2. *Manual*: In this steering program the position of the rear axle(s) is manually adjusted;
3. *Crab steering*: In this steering program all steered axles are positioned in the same direction;
4. *Wall steering*: In this steering program it is possible to drive away from an obstacle with a minimum back swing of the truck.

**CAUTION!**



For all steering programs applies that the crane must be in *transport position*. So NEVER activate a steering program while driving with an erected tower! For all steering programs also applies that the *transversal differential lock* may NEVER be activated!

**Enabling steering system**

**CAUTION!**



Switching between *on the road / off the road steering* may only be done when the vehicle stands still!

For using the *control panel steering system*, the steering system must be switched to *off-the-road mode*.



Therefore switch *steering system on the road / off the road* on the control panel must be switched to *off-the-road mode*:



- The *control panel steering system* becomes active;
- After enabling *off-the-road mode* the maximum vehicle speed is limited to 15 kph (9.4 mph);
- The *longitudinal differential lock* enables automatically:
  - The symbol *longitudinal differential lock* on the main screen flashes till all *longitudinal differential locks* are enabled. After that, the symbol remains continuously active.



A steering program can be chosen.

For more information, see § 3.9.5. *Control panel steering system*.

When enabling the steering programs *manual, crab steering and wall steering*, axle 3 is retracted.

**CAUTION!**



Check if there are no persons on or around the truck in order to prevent dangerous situations.

Retracting of axle 3 is a fully automatic procedure:

1. All axles are fully retracted, the vehicle is lowering;
2. The axle height of axle 3 is blocked;
3. Axles 1, 2, 4 and 5 are adjusted to the *driving mode*, the vehicle moves upwards;
4. The buzzer becomes active.

Axle 3 has lost contact with the ground.

#### Activating steering program *small turning cycle* from *manual, crab steering* or *wall steering*

If steering program *small turning cycle* is chosen while the steering program *manual, crab steering* or *wall steering* is active, the vehicle will level and the retracted axle 3 will be unblocked.

#### Disabling steering system

##### CAUTION!



Switching between *on the road / off the road mode* is only allowed if the vehicle is not moving!

##### CONDITIONS



When switching from *off-the-road mode* to *on-the-road mode*, make sure that all axles are moved to the straight forward position before driving away.

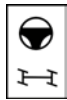

Put switch *steering system on the road / off the road* on the control panel to *on-the-road mode*:

- The maximum vehicle speed is limited to 83 kph (52 mph);
- The *longitudinal differential lock* is automatically disabled:
  - The symbol *longitudinal differential lock* on the main screen flashes till all *longitudinal differentials* are disabled. After that, the symbol disappears.
- The vehicle is automatically *levelled*:
  1. All axles are fully retracted, the vehicle is lowering;
  2. The axle height of axle 3 is unblocked;
  3. The axles are adjusted to the *driving mode*, the vehicle moves upwards;
  4. The buzzer becomes active when levelling is ready;
- The *control panel steering system* becomes inactive.



#### 4.13.5.1. Steering program: Small turning cycle

With this steering program, it is possible to drive with an extra *small turning cycle* (Picture 4-14).



Picture 4-14

#### Activating steering program



Enable steering program *small turning cycle* by using the key on the *control panel steering system*:

- The red indicator above the key becomes active when the steering program can be carried out successfully;
- After enabling the off-the-road mode, the maximum vehicle speed is limited to 15 kph (9.4 mph).

#### Using steering program

Axles 1 and 2 are mechanically steered by the steering wheel, axles 4 and 5 are steering in the opposite direction.

#### Examples

The *display control panel steering system* shows the current steering position of the rear axle.

In combination with the chosen steering program, the current steering position of the vehicle can be determined (Table 4-5).

However, this is just an indication. The real situation may be different.

Message	Description
	All axles are in straight forward position.
	The vehicle will make a slight turn to the left (the position of the rear axle is opposite to the steering direction).
	The vehicle will make a maximum short turn to the right (the position of the rear axle is opposite of the steering direction).

Table 4-5

#### 4.13.5.2. Steering program: Manual

With this steering program the position of the rear axle can manually be adjusted (Picture 4-15).



Picture 4-15

#### Activating steering program



Enable steering program *manual* by using the key on the *control panel steering system*:

- The red indicator above the key becomes active when the steering program can be carried out successfully;
- When enabling the program, axle 3 will be retracted. The buzzer becomes active when the vehicle is ready;
- After enabling the off-the-road mode, the maximum vehicle speed is limited to 15 kph (9.4 mph).

#### Using steering program

Axles 1 and 2 are mechanically steered by the steering wheel, axle 5 can independently be adjusted and axle 4 steers proportionally with axle 5.

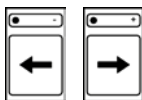

Use the *plus-* and *minus* key on the *control panel steering system* to adjust the steering position of the rear axle:

- The movement of the rear axle is executed immediately.

#### Examples

The *display control panel steering system* shows the current steering position of the rear axle.

In combination with the chosen steering program, the current steering position of the vehicle can be determined (Table 4-6).

However, this is just an indication. The real situation may be different.

Message	Description
	The steering position of the rear axle is in straight forward position.
	The steering position of the rear axle is slightly to the right.
	The steering position of the rear axle is maximum to the left.

Table 4-6



**4.13.5.3. Steering program: Crab steering**

With this steering program all steering axles are steered in the same direction, whereby the vehicle can drive diagonally (*Picture 4-16*).



Picture 4-16

**Activating steering program**



Enable steering program *crab steering* by using the key on the *control panel steering system*:

- The red indicator above the key becomes active when the steering program can be carried out successfully;
- When enabling the program, axle 3 will be retracted.  
The buzzer becomes active when the vehicle is ready;
- After enabling the off-the-road mode, the maximum vehicle speed is limited to 15 kph (9.4 mph).

**Using steering program**

Axles 1 and 2 are mechanically steered by the steering wheel, axles 4 and 5 are steering in the same direction.

When the front axles are further steered than the maximum possible angle of the rear axle, then there will be more friction of the rear wheels.

**Examples**

The *display control panel steering system* shows the current steering position of the rear axle.

In combination with the chosen steering program, the current steering position of the vehicle can be determined (*Table 4-7*).

However, this is just an indication. The real situation may be different.

Message	Description
	All axles in straight forward position.
	The truck will slightly turn diagonally to the right.
	The truck will maximum turn diagonally to the left.

Table 4-7

#### 4.13.5.4. Steering program: Wall steering

With this steering program it is possible to drive away from an obstacle with a minimum swing of the back of the truck (Picture 4-17). The pivot point of the vehicle is situated on the back. The turning circle is significantly greater.



Picture 4-17

#### Activating steering program



Enable steering program *wall steering* by using the key on the *control panel steering system*:

- The red indicator above the key becomes active when the steering program can be carried out successfully;
- When enabling the program, axle 3 will be retracted.  
The buzzer becomes active when the vehicle is ready;
- After enabling the off-the-road mode, the maximum vehicle speed is limited to 15 kph (9.4 mph).

#### Using steering program

Axles 1 and 2 are mechanically steered by the steering wheel, axle 5 is steering very minimal and axle 4 steers proportionally with axle 5.

#### Examples

The *display control panel steering system* shows the current steering position of the rear axle (Table 4-8).

In combination with the steering program *wall steering*, the display always shows the centre position:

Message	Description
	Rear axle in straight forward position.

Table 4-8

#### 4.13.6. Manoeuvring: gear box

The automatic gear box has a so-called *manoeuvring mode*.

The vehicle speed in *manoeuvring mode* is limited to 30 kph (18.7 mph).

##### Manoeuvring in position *DM* or *RM*

- The coupling is not fully closed in *manoeuvring mode*;
- The automatic gear box is not switching.

Manoeuvring in position *DM* or *RM* goes as follows:

1. Turn the rotary switch on the *control panel gear box* to *DM* (manoeuvring forward) or *RM* (manoeuvring backward):
  - On the *display gear box* *DM* or *RM* will appear;
2. Gradually operate the accelerator in the *manoeuvring range*. This is the initial part of the stroke:
  - The coupling closes partly and will close further as the accelerator is pressed further;
  - The vehicle starts to manoeuvre.



##### CONDITIONS



**Manoeuvring by means of the accelerator can only be carried out in the 1<sup>st</sup>, 2<sup>nd</sup> and 3<sup>rd</sup> gear.**

#### 4.14. Driving with a trailer

To tow a trailer, the vehicle is equipped with a towing hook with a 7-pins socket for lighting.

If a buffer beam is present, it must be folded before the trailer can be coupled

(see § 4.15.1. *Folding the buffer beam*).

An optional *trailer connector* will be used when driving with an air braked trailer.

**Maximum mass non-braked trailer**

**CAUTION!**



The legally established maximum mass of a non-braked trailer (load and its own weight) is 750 kg.  
**NEVER** exceed this weight! The maximum nose weight is 350 kg.

**Maximum mass braked trailer**

**CAUTION!**



The maximum weight of a braked trailer (load and its own weight) at a SK599-AT5 is 3,336 kg.  
**NEVER** exceed this weight!

**CAUTION!**

Never mount a towing hook with different characteristics without permission of the national road administration.  
The maximum weight corresponds with the value in the registration certificate.



If these values does not correspond with each other, then the value in the registration certificate is leading.

#### 4.14.1. Coupling of the trailer



**CAUTION!**

Depending on the national laws and regulations, a special driving license may be required to drive with a (heavy) trailer.

For coupling a trailer to the vehicle, the following steps below must be carried out:

1. Fold the buffer beam (see § 4.15.1. *Folding the buffer beam*);
2. Drive the towing hook under the coupling of the trailer or pull the trailer coupling above the towing hook;
3. Attach the steel wire rope or contact-breaking cable on the attachment point of the towing hook;
4. Attach and lock the coupling of the trailer on the towing hook.  
For more information, see the documentation related to the trailer;
5. Attach the plug of the trailer to the plug connection;
6. Check the operation of the lighting according to § 4.3.2. *CHECKLIST: Check vehicle lights.*

#### Coupling trailer with trailer connector

7. When mounting an air braked trailer, also the optional trailer connection must be mounted;
8. Check the operation of the trailer brakes.

#### 4.14.2. Uncoupling of the trailer

For uncoupling the trailer from the vehicle, the following steps below must be carried out:

1. Remove the coupling and lock of the trailer:
  - For more information, see the documentation related to the trailer;
2. Remove the steel wire rope or contact-breaking cable on the attachment point of the towing hook;
3. Remove the plug of the trailer from the plug connection;
4. Remove after use of an air braked trailer the optional *trailer connection*;
5. Unfold the buffer beam (see § 4.15.2. *Unfolding the buffer beam*).

#### 4.15. Buffer beam

The vehicle is equipped with a so-called *buffer beam* as a rear underrun protective device.



**CAUTION!**

If no trailer is used on public roads, then the use of the buffer beam (including lighting) is legally required.

#### 4.15.1. Folding the buffer beam

**CAUTION!**



After folding the buffer beam, check if the pin connections are correctly locked to prevent dangerous situations.

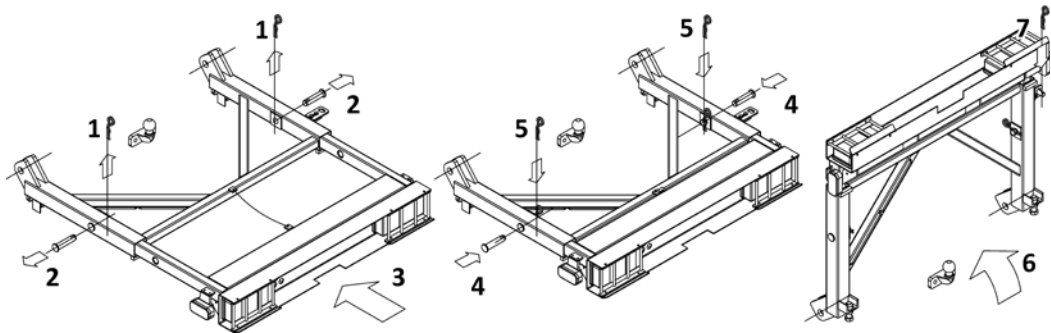

Picture 4-18

By means of *Picture 4-18* the following steps must be carried out to fold the buffer beam:

1. Remove the two R-clips (1);
2. Remove the two pins (2) from the tube;
3. Slide the rear part of the buffer beam (3), till the holes in both tubes (for the benefit of the pin connection) are in one line;
4. Reassemble the two (at step 2) removed pins to the tube (4);
5. Lock the two pins with the (at step 1) removed R-clips (5);
6. Remove the R-clip of the pin on the frame (7);
7. Tilt the entire buffer beam vertically against the frame of the vehicle (6);
8. Lock the buffer beam with the (at step 6) removed R-clip (7);
9. Remove the plug from the plug connection.

#### 4.15.2. Unfolding the buffer beam

**CAUTION!**



After unfolding the buffer beam, check if the pin connections are correctly locked to prevent dangerous situations.

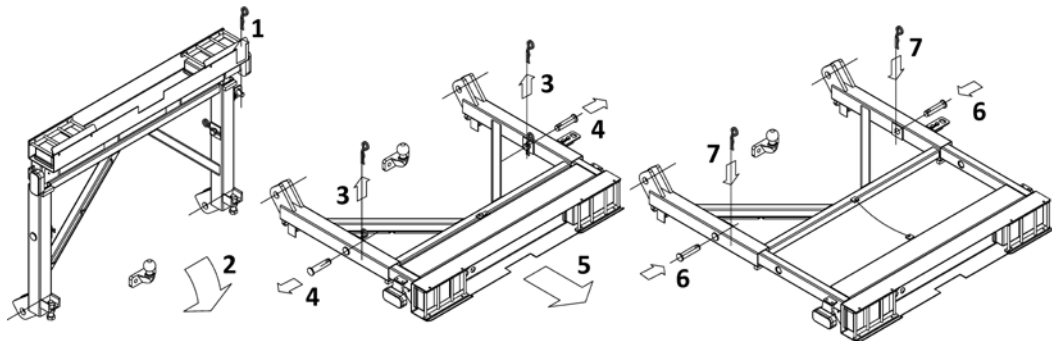

Picture 4-19

By means of *Picture 4-19* the following steps must be carried out to unfold the buffer beam:

1. Remove the R-clip of the pin on the frame (1);
2. Tilt the entire buffer beam horizontally (2);
3. Mount the at step 1 removed R-clip in the pin on the frame (1);
4. Remove the two R-clips (3);
5. Remove the two pins (4) from the tube;
6. Slide the rear part of the buffer beam (3), till the holes in both tubes (for the benefit of the pin connection) are in one line;
7. Mount the two at step 5 removed pins in the tube (6);
8. Lock the two pins with the at step 4 removed R-clips (7);
9. Attach the plug to the plug connection.

#### 4.16. Driving with an erected tower

*Driving with an erected tower* means driving with a fully unfolded crane.

**CAUTION!**



Spierings Mobile Cranes advises only to drive with an erected tower, when the regular unfolding and folding is not possible because of abnormal conditions (e.g. on a small construction site).

**CAUTION!**



- *Driving with an erected tower* is a risky act, which is exclusively carried out by the own responsibility of the driver;
- A possible risk is unforeseen instability which may result to a falling unfolded crane. Align this risk with the responsible person on the working site!
- *Driving with an erected tower* may only be carried out by skilled, qualified and trained personnel;
- Check if there are no persons on or around the crane while driving with an erected tower;
- Inform all relevant persons clearly.



#### 4.16.1. Conditions for driving with an erected tower

##### CAUTION!



*Driving with an erected tower* is allowed, but only under the following very strict conditions.

If one or more conditions cannot be met, then it is **STRICTLY FORBIDDEN** to drive with an erected tower!

##### CONDITIONS

- At least one qualified and trained person gives instructions during the moving of the crane:
  - Communicate clear signs and signals in advance;
- The windforce is **NOT** higher than windforce 3 Bft (5.4 m/s);
- The upper frame is locked, with the jib over the front of the truck (see *Picture 4-20, 1*);
- The jib is in horizontal position, not 30° topped (*Picture 4-20, 1*);
- The crane is mounted halfway, thus not fully erected: only the intermediate tower is extended (*Picture 4-20*);
- There is no load on the hoisting hook (*Picture 4-20, 2*);
- The trolley and the hoisting block are positioned as shown in *Picture 4-20, 3*;
- The diesel engine of the crane must be **TURNED OFF**;
- The suspension must be **BLOCKED**:
  - Check if the symbol *axle blocking* on the main screen is active;
- The tyre pressure of all tyres must be at least 9.0 bar (measured with cold tyres);
- The outrigger beams are all *fully extended*, with the outrigger plates approx. 10 cm above the ground, reachable by extending all axles simultaneously (*Picture 4-21*):
  - Retract the outrigger cylinders carefully one by one;
  - Take care that the outriggers and outrigger plates will not encounter obstacles during the moving of the crane;
- The road is levelled and paved, so the weight is equally distributed on the wheels. Use drive plates at a soft soil;
- The maximum tilt of 2° may **NOT** be exceeded. The current tilt can be read on the spirit level in the truck cab (*Picture 4-22*);
- The maximum permissible acceleration and deceleration is 1 m/s<sup>2</sup>. Accelerate and decelerate gradually.
- The maximum permissible speed is 2.4 kph (1.5 mph) (40 m/min):
  - Transfer case in off-the-road mode;
  - Gear box in first gear.



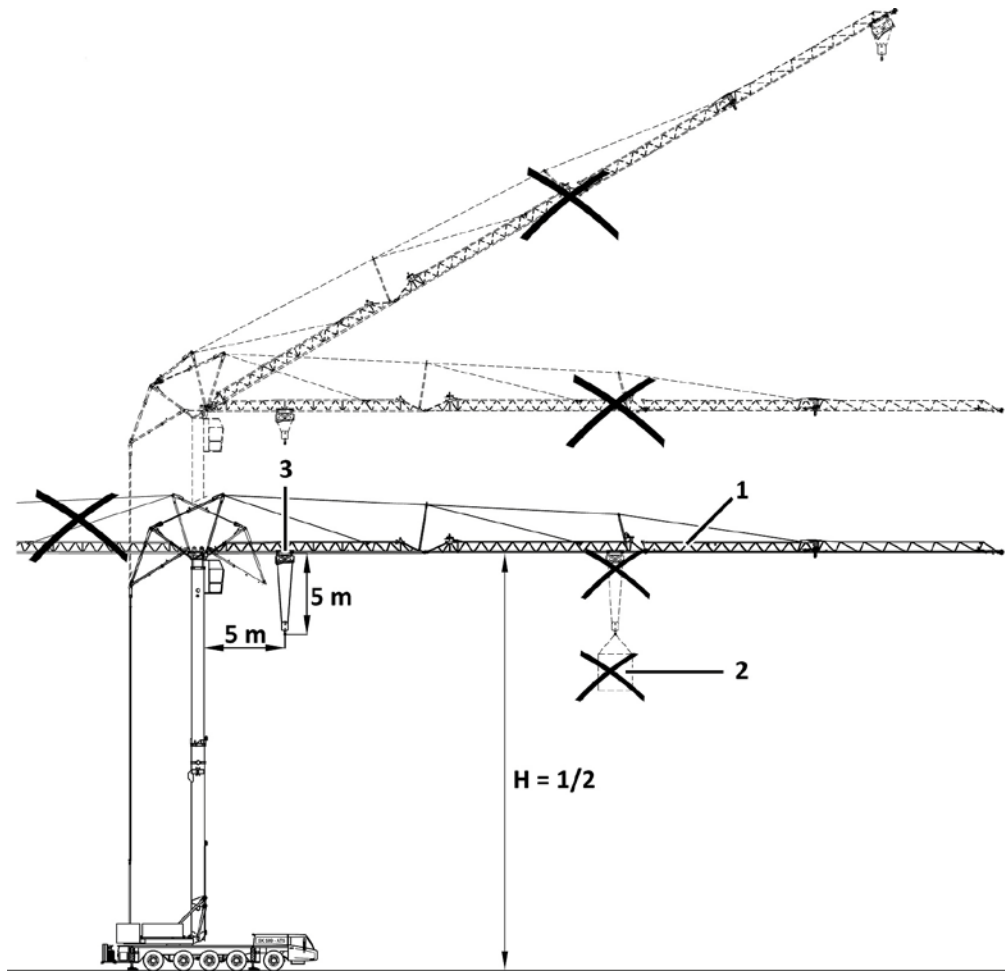

Picture 4-20

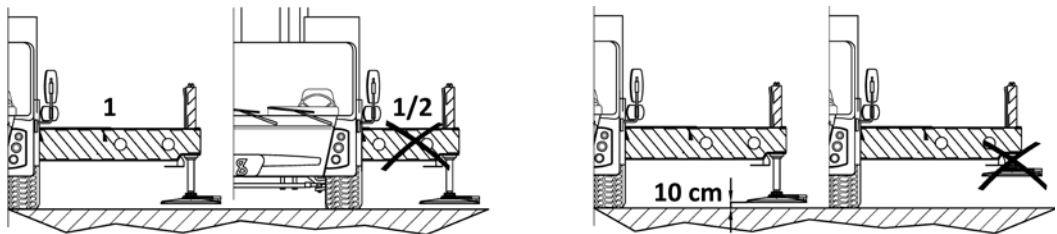

Picture 4-21

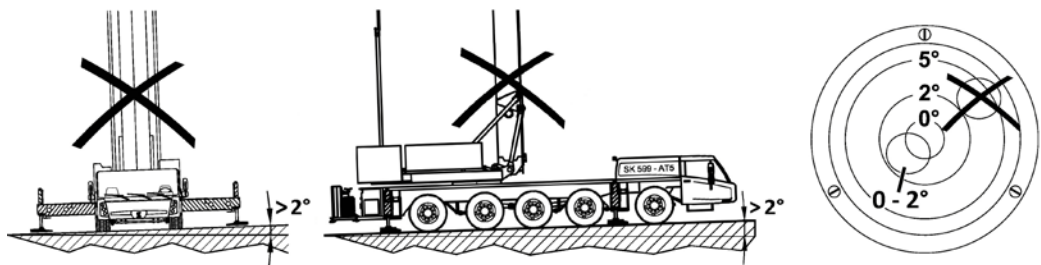

Picture 4-22

#### 4.16.2. Instructions for driving with an erected tower

**CAUTION!**



- **Driving with an erected tower is a risky act, which is exclusively carried out by the own responsibility of the driver.**
- **The instructions are just meant to help the driver in his preparations for driving with an erected tower.**
- **Spierings Mobile Cranes is NOT responsible for missing instructions or unforeseen situations, which may occur during driving with an erected tower.**

#### Check the roadway and the new working site

1. Check if the roadway is levelled:
  - The maximum permissible tilt of the truck is 2°;
2. Check if there are no sharp turns along the driving path;
3. Check if the load capacity of the soil is sufficient:
  - Are there no cavities or pipes such as sewage systems, embankments, wells, cellars?
  - Is the soil hardened or are there suitable drive plates available?
  - Are there transitions from hard to soft soil?
4. Check if there is enough space to drive with an erected tower:
  - Mind the width of the vehicle with extended outriggers.

#### Check the position / status of the crane

1. Check the current wind force on the *touch screen*:
  - The maximum permissible wind force is 3 Bft (5.4 m/s);
  - Compare the current value with the weather forecast;
  - The wind force may fluctuate during time. Take this into account;
2. Check if the tyre pressure of all tyres is in the range of 9.0 – 9.2 bar (measured at cold tyres) (see § 11.5.2. *Tyre pressure*);
3. Check if the crane is build at *half height* (NOT at full height):
  - Only the intermediate tower is extended;
4. Check if the jib is in *horizontal position* (NOT 30° topped):
  - If not, top the crane to *horizontal jib*;
5. Check if there is no load in the hoisting hook;
6. Let the trolley travel in or out till it is positioned 5 meters away from the tower:
  - Lift or lower the hoisting block till it is situated 5 meters away from the jib;
  - The upper frame is locked, with the jib over the front of the truck:
    - Check if the upper frame is correctly locked;
7. Turn off the *diesel engine crane*;
8. Check if the outrigger beams are all fully protracted (*full outrigger base*);
9. Operate switch *all axles up / down* to create a ground clearance of approx. 10 cm of the outrigger plates.



Drive off

**CAUTION!**

 **While driving with an erector tower, NEVER activate the features *levelling*, *off-the-road mode* and *longitudinal and transversal differential lock*!**



1. Switch the transfer case to *off-the-road mode* (turtle) using the switch *transfer case on-the-road /off-the-road mode* on the control panel:



- The symbol *off-the-road mode* will be active on the *main screen*;



2. Check if the suspension is blocked:

- If the symbol *axle blocking* on the *main screen* is active, the spring accumulators are disabled and the suspension is blocked;



3. Turn the rotary switch to *position D*:

- The gear box switches to *forward*;
- **Keep the foot on the brake to prevent driving away unexpectedly!**



- The *display gear box* shows the current gear;



4. Switch the gear box to *manual mode* by moving the *gear lever* in automatic mode to the left once and release the lever again;



5. Switch the gear box to the 1<sup>st</sup> gear by moving the gear lever in the direction of the - (minus) and release the lever again:



- Repeat the movement till *1* will appear on the *display gear box*;

6. Keep the foot of the brake en push gradually on the accelerator, so that the vehicle gradually speeds up:

- The maximum permissible acceleration and deceleration is 1 m/s<sup>2</sup>;

7. While driving keep an accurate eye on the speedometer and the spirit level in the truck cab (see *Picture 4-23*):

- The maximum permissible vehicle speed is 2.4 kph (1.5 mph)(40 m/min);

- The maximum permissible tilt of the vehicle is 2°.



Picture 4-23

## 4.17. Towing

### CAUTION!

- Before towing of the vehicle, contact Spierings Mobile Cranes;
- The indicated instructions are just meant to help the driver in his preparations before towing. Spierings Mobile Cranes is NOT responsible for missing instructions or unforeseen situations, which may occur while towing;
- Depending on the cause of towing, a balanced choice of the measures to be taken must be made;
- Towing and the measures before towing may only be carried out by skilled, qualified and trained personnel;
- If towing is necessary, take into account the maximum length of the vehicle combination (the towing and towed vehicle, including towing bar);
- Towing is only allowed if the crane is in *transport position*;
- The shunting coupler is designed for a maximum pulling capacity of 10 tonnes;
- Tow the vehicle only with a an appropriate towing bar;
- Tow the vehicle with the lowest possible speed, maximum 20 kph (12.5 mph). Gradually accelerate the vehicle combination to prevent damage on the vehicle;
-  Starting the diesel engine by towing is not possible due to the automatic gear box in the drive line.

If the vehicle needs to be towed, the state of the vehicle must be determined:

- If the diesel engine, the service brake and the steering system function, the vehicle can be towed by a heavy tow truck or salvage truck;
- If the diesel engine, the service brake and the steering system do not function properly, the vehicle must be towed by a special salvage truck.

The distance over which the vehicle must be towed, is relevant.

There is a difference between:

- Towing the vehicle over a short distance (out of the dangerous area);
- Long(er) distances (> 100 m).

In most cases, proper functioning of the service brake and the steering system is depending on the diesel engine.

If the diesel engine is working properly:

- The air circuit remains under pressure, so while driving the brake can be used and the parking brake can be released;
- The power-assisted steering remains active.

#### 4.17.1. Towing with functioning diesel engine, service brake and steering system

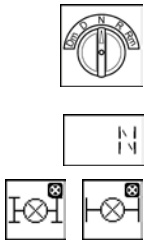

1. Start the diesel engine of the truck (see § 4.4. *Start diesel engine truck*);
2. Put the gear box in its *neutral position N* by using the rotary switch:
  - On the *display gear box* will appear *N*;
3. Check if the *longitudinal and transversal differential locks* are **DISABLED**:
  - See the *differential indication screen* for an overview of the enabled *longitudinal and transversal differential locks*;
4. Remove the cover of the central console;
5. Operate switch *transfer case neutral* in the central console to switch the transfer case to its *neutral position* (see *Picture 4-24*);



Picture 4-24



6. Check if the symbol *transfer case neutral* on the main screen is active;

**CAUTION!**



**Be sure that the gear box and the transfer case are in their *neutral positions*, otherwise the driving line can be heavily damaged.**

7. Remove the cover in the middle of the front bumper and mount the supplied shunting coupler (*Picture 4-25*). This coupler is situated behind the co-driver's seat in the truck cab.



Picture 4-25



8. Mount the towing vehicle with a towing bar to the shunting coupler of the towed vehicle, after which this can be towed;
9. Operate switch *vehicle lighting* on the control panel to enable the *base lighting* and the *low beam*;
10. Operate switch *hazard warning lights* on the control panel to enable the hazard warning lights:
  - Check if all hazard warning lights are active;
11. Release the parking brake:
  - Pull out the lever and move it forwards.

**CAUTION!**



**Check if the parking brake is released, otherwise the braking system can be heavily damaged.**

#### 4.17.2. Towing with a malfunctioning diesel engine

When the diesel engine can no longer run, the same procedure can be followed as described in § 4.17.1. *Towing with functioning diesel engine, service brake and steering system.*

However, there are some additional problems.

##### **The system is not building air pressure**

1. The service brake is not functioning properly (see § 4.8.1. *Service brake*);
2. The parking brake cannot be released (see § 4.17.2.2. *Releasing the parking brake*);
3. The transfer case cannot be switched to its *neutral position* (see § 4.17.3. *Enabling transfer case to neutral*):
  - If this does not work, then some drive shafts must be disassembled (see § 4.17.3.1. *Remove drive shafts on output shafts of the transfer case*);

##### **The oil pump from the diesel engine is not supplying oil pressure**

4. The power-assisted steering is not (fully) functioning properly (see § 4.17.3.2. *Power-assisted steering*).

#### 4.17.2.1. Service brake when towing with malfunctioning diesel engine

##### Air pressure of external compressor

If the vehicle must be moved over a long(er) distance, there should be external air pressure present. The *filling nipple A* above the outrigger beam on the right front (see *Picture 4-26*) can be connected to the air line of an external compressor.

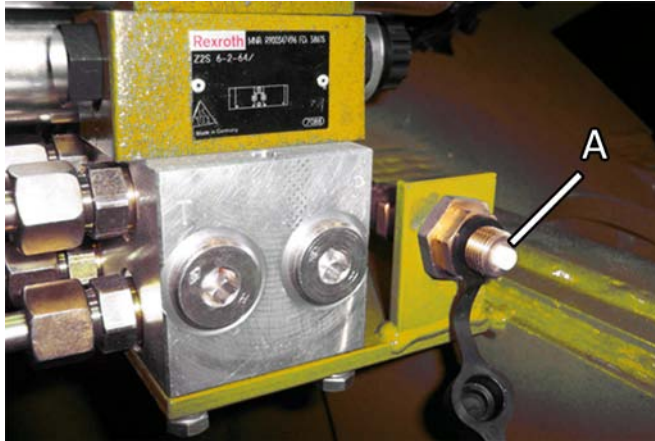

Picture 4-26



**CAUTION!**

The air pressure in the system must be at least 9.0 bar.

The air circuit is pressurized by the external compressor:



- Check the *air pressure gauge circuit 1 and 2* on the *main screen*:
  - The air pressure in the system must be at least 9.0 bar.

The service brake can be used again and the parking brake will be released.



**CAUTION!**

When there is towing without a functioning service brake, the towing vehicle must have sufficient mass and braking force to come to a safe stop.



#### 4.17.2.2. Releasing the parking brake when towing with malfunctioning diesel engine

When an external compressor is connected, the parking brake can be released by using the *parking brake lever*.

##### Mechanical releasing of the parking brake

When no external compressor is used, the parking brake can be mechanically released by taking away the spring tension of all parking brake boosters.

##### CAUTION!

- The parking brake may only mechanically be released if pneumatic release is absolutely NOT possible;
- The parking brake boosters must be put under spring tension again directly after towing to prevent dangerous situations;
- Before mechanically releasing the spring tension of the parking brake boosters, block the wheels with wheel chocks to prevent unforeseen rolling of the vehicle;
- NEVER lie down in front or at the rear of the wheels during mechanically releasing the spring tension of the parking brake boosters.



To release the parking brake mechanically, the next steps must be carried out.

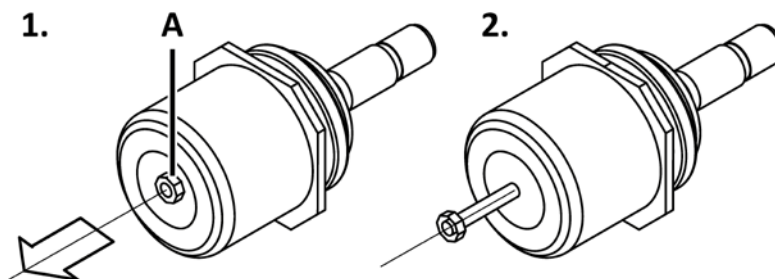

Picture 4-27

1. Turn the *hexagonal head screw A* fully out of the parking brake booster at the rear (*Picture 4-27*);
2. Do this twice per axle (left and right) for axles 2, 3 and 4.

The parking brake is released when the hexagonal head screw of all parking brake boosters are fully turned out:



- The indicator *status braking system* remains active.

#### 4.17.3. Enabling transfer case to neutral position

When an external compressor is connected or when there is sufficient air pressure in the secondary air pressure vessel, the transfer case can be switched to its *neutral position*.

- Switch the *transfer case* to its *neutral position* by enabling switch *transfer case neutral* in the central console:
  - Check if the symbol *transfer case neutral* on the *main screen* is active.



#### 4.17.3.1. Remove drive shafts on output shafts of the transfer case

If no external compressor is used, then the drive shafts on the output shafts of the transfer case need to be removed.

**CAUTION!**



Support the drive shafts before loosening the bolts in the flange.  
This prevents personal injury or damage by unexpected falling of the shafts.  
The weight of the drive shafts is 25 to 60 kg each.

**CAUTION!**



If the drive shafts on the output shafts of the transfer case are removed, the emergency steering pump is not functioning.  
The power-assisted steering is completely eliminated and the vehicle is hard to handle (see *Chapter 12. Steering system*).

#### 4.17.3.2. Power-assisted steering

**CAUTION!**



Only the mechanically steered axles will function, increasing the turning circle significantly (see *Chapter 12. Steering system*).

**CAUTION!**



The vehicle is steering considerably heavier by the elimination of the power-assisted steering (see *Chapter 12. Steering system*).

The steering pumps which are powered by the diesel engine, will deliver no more oil, eliminating the power-assisted steering largely. Only the emergency steering pump delivers oil for the power-assisted steering. However, this pump only delivers oil when the vehicle is moving (> 5 up to 8 kph) (> 3.1 up to 5 mph).

The rear axle steering is completely out of operation. The steering system ensures axles 4 and 5 to centre itself and to operate rigid. The two front axles remain normally steerable.

#### 4.17.4. Towing with damage to the transfer case

If the transfer case is defective, the same procedure can be followed as described in § 4.17.1. *Towing with functioning diesel engine, service brake and steering system.*

However, there are some additional problems:

1. The drive is eliminated:
  - Remove the drive shafts on the output shafts of the transfer case.  
For more information, see § 4.17.3.1. *Remove drive shafts on output shafts of the transfer case.*
2. The power-assisted steering is not (fully) functioning properly.  
For more information, see § 4.17.3.2. *Power-assisted steering.*

#### 4.17.5. Towing with damage to the driven axles

Only skilled, qualified and trained personnel is in this situation allowed to take measures for towing of the vehicle.



**CAUTION!**

**If there are any questions or doubts, please contact Spierings Mobile Cranes.**



## 5. Maintenance truck

### 5.1. When is the right time to thoroughly inspect your Spierings crane?

When your Spierings crane is used in the course of the years, parts wear out and malfunctions and/or defects occur more frequently. The average service life of the crane depends on crane type, use of the crane, history and maintenance approx. 15 to 20 years based on maximum 8 operating hours per day, five days a week. When do you need to thoroughly inspect your crane?

- If several crane functions such as erecting and/or folding are slow and inaccurate or frequent malfunctions occur;
- If you do not fully know the crane's history, for instance if the crane is a second hand crane and commercially purchased with an incomplete Crane's Logbook;
- If the crane is older than 15 years, the crane has made many operating hours and is daily erected and folded;
- If the crane is used intensively and/or a lot is overloaded;
- If you receive complaints about oil leakage, cracks or excessive noise;
- If the annual inspections are not carried out.

#### What does thoroughly inspected mean?

The thorough inspection means that all the construction parts of the crane and truck, which are part of the crane function of the machine, are inspected accurately. It may be necessary to disassemble some parts of the crane and drive components. These may include ty bars, toothed wheels and bearings in reduction gear units and seals in cylinders.

The inspection determines whether the service life can be extended or replacements of parts is necessary.

#### 5.1.1. Electronic component

The crane control is the brain of the crane. It controls the machine and all electronic and hydraulic systems from the moment you start up the crane. This also includes the operation and switches.

The control and the components before and after the input and output signals of the controller have at normal use and proper maintenance a service life of approx. 20 years.

#### 5.1.2. Drive component of the crane

The engine and hydraulic pumps, called power pack, is the beating heart of the crane. The power pack provides all crane functions, which include erecting, hoisting, slewing, trolley travelling and folding.

Due to wear its service life at normal use and proper maintenance is approx. 15 to 20 years.

### 5.1.3. **Jib sections and towers**

These are the crane constructions which form an important part of the crane. Depending on the crane type, crane part, history and load the service life at normal use and proper maintenance is approx. 15 to 20 years. Extension is possible only after thorough inspection by an authorized body.

### 5.1.4. **Ty bars, A-frames, erecting cylinder and luffing cylinders**

These components ensure that all forces are directed in the right way. These are critical components of the crane. Depending on the crane type, crane part, history and load the service life at normal use and proper maintenance is approx. 15 to 20 years. Extension is possible only after thorough inspection by an authorized body.

### 5.1.5. **Lift**

This is the elevator which brings the operator to the crane cabin. The service life at normal use and proper maintenance is approx. 20 years.

### 5.1.6. **Outrigger system**

The outrigger system is an important part of the crane and provides de stability during erection, crane operation and folding. Depending on the crane type, history and load the service life at normal use and proper maintenance is approx. 15 to 20 years. Extension is possible only after thorough inspection by an authorized body.

#### **Disclaimer**

The above mentioned service life expectations are highly dependent on the use, interim maintenance and events. "Minor incidents" which may lead to impact loads in the crane structure can considerably shorten the service life expectations.

No rights may be derived from the mentioned service life expectations, nor can it lead to an expansion of warranty obligations and/or any liability on the part of the supplier and/or producer of Spierings cranes. The user of a Spierings crane is explicitly responsible for proper use and proper maintenance of the crane.

## 5.2. Maintenance truck after commissioning



### INFORMATION!

**Spierings Mobile Cranes only guarantees a long period in which the vehicle is functioning optimally, if the maintenance schedule is followed.**

Maintain the truck according to the prescribed maintenance schedule.

For more information, see § 5.2. *Maintenance schedule truck*.

Carry out a daily visual inspection. Timely identification of a leakage, problem or deviation can prevent far-reaching problems.

The service intervals should preferably be carried out in a well-equipped workshop.



### INFORMATION!

**For specifications see *Chapter 14. Specifications truck*.**



### CAUTION!

**Inspections and/or changes must be documented in the Crane's Logbook.**

### 5.2.1. First service truck

After the first 300 to 400 operating hours, the first service must be carried out.

For more information, see § 5.2. *Maintenance schedule truck*.

In most cases the first service of the truck will be carried out simultaneously with the first service of the crane.

The current amount of operating hours can be read from the *hour counter diesel engine* on the *main screen* (see § 3.9.2.1. *Main screen: General screen*).

### 5.3. Maintenance schedule truck

The maintenance schedule relates to the use of the truck under normal operating conditions.

When operating at extraordinary conditions, please consult Spierings Mobile Cranes.

#### INFORMATION!



Under *normal operating conditions* is defined as:

- 40-hour working week;
- 15,000 – 30,000 km/year (9,375 - 18,750 miles/year);
- Ambient temperature between -10 °C up to 30 °C.

#### CAUTION!



- If during inspection it reveals that a component is in a bad condition, the affected component must be replaced immediately!
- General safety and reliability of the crane at overdue maintenance will be called into question!

The service issues which take place daily, weekly or bi-monthly, will logically also receive attention at the annual maintenance.

#### Explanation of codes in the maintenance schedule

- C = Check;
- CL = Check level;
- L = Lubricate;
- P = Clean (purify);
- D = Drain;
- X = Refresh / Replace.



**5.3.1. Maintenance schedule diesel engine truck**

Maintenance	1 <sup>st</sup> service truck	Daily	Weekly	Bi-monthly	30,000 km/ yearly	Other
Engine oil	CL	CL			X	
Oil filter					X	
Cooling system	C			C		
Coolant	CL		CL			4 yearly replaced
Anti-freeze concentration					C	
Radiator / Intercooler					P	
Air intake system	C			C		
Air filter	C			P	X	
Fuel system					C	
Fuel pre-filter / Water separator	C			D	X	
Fuel filter	C				X	
AdBlue filter					X	
Air filter / Oil separator EAS					X	
Poly-V belts	C				C	2 yearly replaced
Exhaust system				C		
Valve clearance					C	

Table 5-1

**5.3.2. Maintenance schedule drive line**

Maintenance	1 <sup>st</sup> service truck	Daily	Weekly	Bi-monthly	30,000 km/ yearly	Other
Gear box	C			C		
Oil gear box	X			CL	X	
Oil filter retarder	X				X	
Transfer case	C			C		
Oil transfer case	X			CL		2 yearly replaced
Axles	C			C		
Oil differentials	X			CL		4 yearly replaced
Oil axle hubs	X			CL		2 yearly replaced
Tyres	C		C			
Tyre pressure			C			
Brake linings					C	

Table 5-2

**5.3.3. Maintenance schedule steering system**

Maintenance	1 <sup>st</sup> service truck	Daily	Weekly	Bi-monthly	30,000 km/ yearly	Other
Full steering system				C	L	

Table 5-3

**5.3.4. Maintenance schedule electrical system truck**

Maintenance	1 <sup>st</sup> service truck	Daily	Weekly	Bi-monthly	30,000 km/ yearly	Other
Control panel lighting		C			C	
Batteries	CL			CL		

Table 5-4

**5.3.5. Maintenance schedule lighting truck**

Maintenance	1 <sup>st</sup> service truck	Daily	Weekly	Bi-monthly	30,000 km/ yearly	Other
Lighting		C			C	

Table 5-5

**5.3.6. Maintenance schedule hydraulic system truck**

**CAUTION!**

After refreshing the hydraulic oil (for the first time after 5 years), the oil must be analysed.

Then have the oil analysed every 2 years. Refresh the hydraulic oil if necessary according to the analysis.

Maintenance	1 <sup>st</sup> service truck	Daily	Weekly	Bi-monthly	30,000 km/ yearly	Other
Hydraulic oil	CL			CL		
Hydraulic fine filter	X					2 yearly replaced
Hydraulic coarse filter	X				X	
Accumulators					C	
Hoses and connections				C		

Table 5-6

**5.3.7. Maintenance schedule pneumatic system**

Maintenance	1 <sup>st</sup> service truck	Daily	Weekly	Bi-monthly	30,000 km/ yearly	Other
Air dryer filter	C					2 yearly replaced
Air vessels				D		
Oil atomizer	CL			CL		
Water separator	C			D		
Braking pressure					C	
Hoses and connections					C	

Table 5-7

**5.3.8. Maintenance schedule lubrication truck**

**INFORMATION!**  
 Remove excess grease timely to prevent damage.

Maintenance	1 <sup>st</sup> service truck	Daily	Weekly	Bi-monthly	30,000 km/ yearly	Other
Automatic lubrication system	C		P	CL		
Manual lubrication	L		P	L		

Table 5-8

**5.3.9. Maintenance schedule others truck**

**CAUTION!**  
 The fire extinguishers must be checked annually by an approved body.  
The user himself must arrange this inspection.

Maintenance	1 <sup>st</sup> service truck	Daily	Weekly	Bi-monthly	30,000 km/ yearly	Other
Windscreen washer fluid	CL	CL				
Fire extinguisher					C	
Seat belt		C			C	

Table 5-9

**Air conditioning**

The air conditioning system contains coolant under high pressure.

**It is NOT ALLOWED to remove parts of the air conditioning system!**

**CAUTION!**  
 Working on the air conditioning system may only be carried out by qualified personnel!

**INFORMATION!**  
 If the air conditioning system is not functioning properly, it should be restored as soon as possible to prevent major damage to the system.  
When there is doubt, please contact Spierings Mobile Cranes.

## 6. Electrical system



**INFORMATION!**

For more information, see the electrical diagrams in the Annex.

### 6.1. Alternator

The on-board voltage of the truck is 24 V. There are two batteries connected in series.

During running of the truck engine, these batteries are charged by an alternator, which is driven by the truck engine (see *Picture 6-1*).



*Picture 6-1*



If the batteries are not charged by the alternator while running the engine, the indicator *status battery* will become active.

## 6.2. Batteries



### TOXIC SUBSTANCES!

Battery acid is harmful to man and environment. Handle with great care!



If the ignition is turned on, the *battery light* will illuminate. The light becomes inactive when the alternator is working. If the light illuminates weakly, it is a sign that the battery needs to be replaced (see § 14.3. *Specifications electric system truck*).

### 6.2.1. Checking batteries

The two batteries are situated in the left-hand engine cowling, behind the electrical cabinet (see *Picture 6-2*). The protective cover of the batteries is not shown in the picture.



Picture 6-2



### CHECK / TEST!

Check the batteries of the truck every two months.

Checking the batteries must be carried out as follows:

1. Erect the crane until the tower is vertically positioned and secured;
2. Remove the left-hand cover plate of the engine cowling;
3. Remove the protective cover of the batteries;
4. Check the batteries for the following issues:
  - The fluid level must be above the minimum level (see marking on the battery);
  - The ropes may not be damaged;
  - The battery clamps of the ropes must be well tightened;
  - The battery terminals must be well covered;
  - The batteries must be well tightened;
  - The batteries may not be damaged;
5. Test the state of the battery by means of a battery tester or acidimeter;
6. Replace the batteries when they are damaged or not functioning properly (see § 6.2.3. *Replacing batteries*);
7. Mount the protective cover and the cover plate;
8. Fold the crane.

### 6.2.2. Charging batteries



**CAUTION!**

**Do not charge the batteries of the truck by using the batteries of the superstructure diesel engine.  
Especially in the winter, there is a danger of completely empty batteries.**

To charge the batteries, a charger and a cable with NATO connection are needed. When using a quick charger, all battery cables must be dismantled with regard to damage to electronic components. When using a normal charger, this is not necessary.

Charging the batteries must be carried out as follows:

1. Make sure the engine is not running:
  - Remove the key from the ignition;
2. Open the right-hand engine cowling;
3. Connect the cable with NATO-connection to the connection of the truck and the charger;
4. Turn on the battery charger;
5. Always turn off the battery charger after use;
6. Disconnect the cable with NATO-connection;
7. Close the right-hand engine cowling;
8. Start the engine and let it run for a few minutes.

#### Recharging batteries by using a quick charger

When using a quick charger, all cables must be removed from the battery clamps and the quick charger must be attached directly to the battery terminals.

### 6.2.3. Replacing batteries



**CAUTION!**

**Always replace the batteries by new ones of the same type and size.**

It is recommended to check the batteries first before replacing.

Replacing the batteries must be done as follows:

1. Turn off the ignition of the truck and remove the ignition key;
2. Erect the crane till the tower is in vertical position;
3. Remove the left-hand cover plate of the engine cowling;
4. Unscrew the nut and remove the protective cover of the batteries;



**CAUTION!**

**Always loosen the battery clamps of the – terminal first, before loosening the battery clamps of the + terminal! When dismantling, always follow this order.**

5. Always loosen the battery clamps on the – *terminal* first, then the battery clamps of the + *terminal*;

6. Remove the battery holder;
7. Remove the old batteries from the battery compartment and insert new ones;
8. Tighten the new batteries with the battery holder;
9. First mount the battery clamps of the + *terminal* and then the battery clamps of the – *terminal*;
10. Grease the terminals well by using acid-free grease (for instance Vaseline);
11. Cover the terminals with isolation covers;
12. Mount the protective cover of the batteries and fasten it with the nut;
13. Mount the left-hand cover plate of the engine cowling;
14. Start the engine and let it run for a few minutes.

When (dis)mounting the battery clamps, always follow this order.

For more information, see § 6.2.1. *Checking batteries.*

### 6.3. Main switch

#### **ELECTRICAL VOLTAGE!**



**During work on the electric circuit or welding on the vehicle, interrupt the electrical system by using this switch.**



When using the main switch in the truck cab, the electrical system of the truck can be interrupted.



## 6.4. Fuses

### CAUTION!



Always replace a defective fuse immediately by a fuse with the same current.  
For more information, see the electrical diagram.

### 6.4.1. Fuses in the fuse box

In the fuse box in the dashboard (co-driver's side) in the truck cab, there is a circuit board mounted with fuses and a relay.

Also on the top of the fuse box there are some fuses present.

An overview of fuses, which is situated on the inside of the cover, shows extra information about the fuses (see *Picture 6-3*).

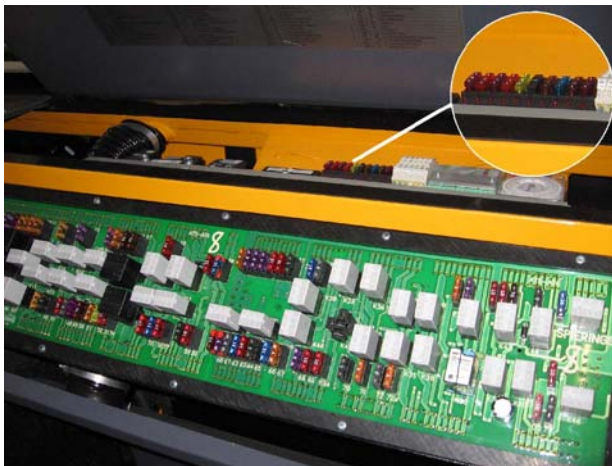

Picture 6-3

### 6.4.2. Main fuses

At the top of the dashboard (co-driver's side) of the truck, there are two main fuses mounted (see *Picture 6-4*).

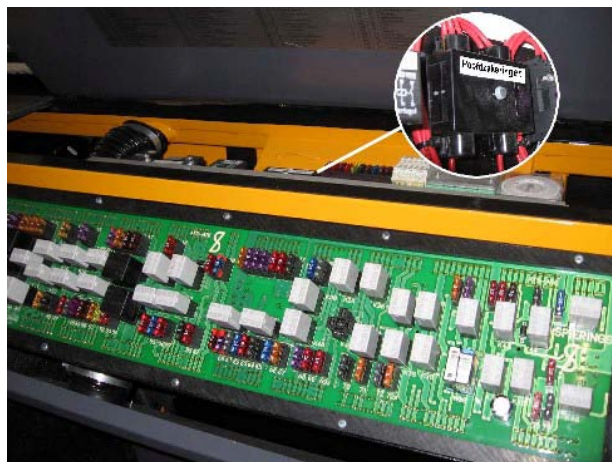

Picture 6-4

### 6.4.3. Fuses in the control cabinet of the truck

The fuses of the suspension system and outrigger system are situated in the control cabinet (left-hand engine cowling) (see *Picture 6-5*).



*Picture 6-5*

## 7. Lighting



### INFORMATION!

For more information, see the electrical diagram in the Annex.



### CHECK / TEST!

Check the lighting of the truck every day before driving off and at the annual maintenance.



### CAUTION!

Do NOT touch the halogen lights with bare hands.  
By touching with bare hands, the service life of the light is strongly shortened.

## 7.1. Low beam

For replacing the lamps, first the bumper needs to be removed (see *Picture 7-1*).



Picture 7-1

1. Unscrew the *bolts 1* (*Picture 7-1*) at the lower side of the bumper;
2. Unscrew the *inner socket head screws 2* at the upper side of the bumper;
3. Remove the bumper from the *supports 3*.

### Replacing lamp

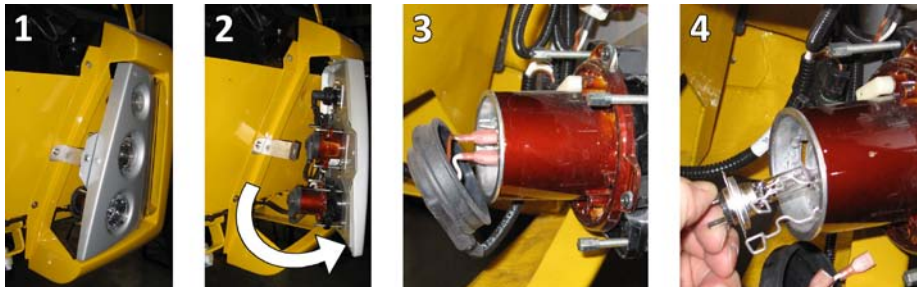

Picture 7-2

Carry out the following steps for replacing a lamp (see *Picture 7-2*):

1. Unscrew the fitting (*Picture 7-2, 1*);
2. Rotate the fitting outwards (2);
3. Remove the rubber hood of the lower lamp holder (3);
4. Replace the lamp (4):
  - Remove the cables;
  - Release the clamping spring and turn it away from the lamp base;
  - Replace the lamp;
  - Mount the clamping spring;
  - Connect the cables;
5. Check the operation of the lamp;
6. Mount the fitting;
7. Mount the bumper.

## 7.2. Main beam

### Removing bumper

For replacing the lamps, first the bumper needs to be removed .

For more information, see § 7.1. *Low beam*.

### Replacing lamp

The main beam is mounted in the middle lamp holder and replacing this lamp follows the same procedure as replacing the low beam (see § 7.1. *Low beam*).

## 7.3. Parking light

### Removing bumper

For replacing the lamps, first the bumper needs to be removed.

For more information, see § 7.1. *Low beam*.

### Replacing lamp

The lamps of the parking lights are situated in the lamp holders of the main beam.



Picture 7-3



Picture 7-4

1. Turn the lamp holder a quarter turn counterclockwise (see *Picture 7-3*);
2. Take the holder and replace the bayonet lamp (see *Picture 7-4*);
3. Check the operation of the lamp;
4. Mount the holder with the lamp by turning the lamp holder a quarter turn clockwise;
5. Mount the fitting;
6. Mount the bumper.

## 7.4. Direction indicator

### 7.4.1. Front direction indicator

#### Removing bumper

For replacing the lamps, first the bumper needs to be removed.

#### Replacing lamp

The direction indicator is situated at the top of the fitting.

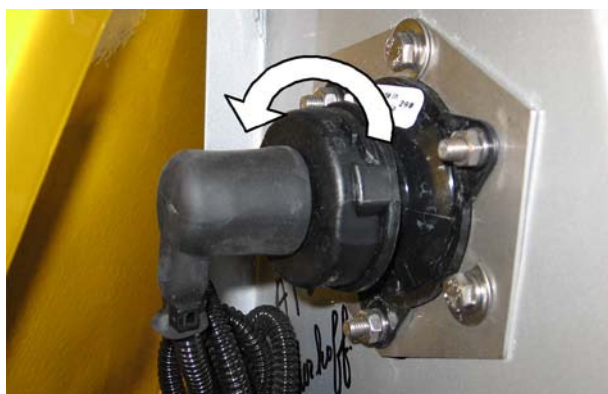

Picture 7-5



Picture 7-6

1. Turn the lamp holder a quarter turn counterclockwise (see *Picture 7-5*);
2. Take the holder and replace the lamp (see *Picture 7-6*);
3. Check the operation of the lamp;
4. Mount the holder with the lamp by turning the lamp holder a quarter turn clockwise;
5. Mount the fitting;
6. Mount the bumper.

## 7.4.2. Side direction indicator

### Replacing lamp

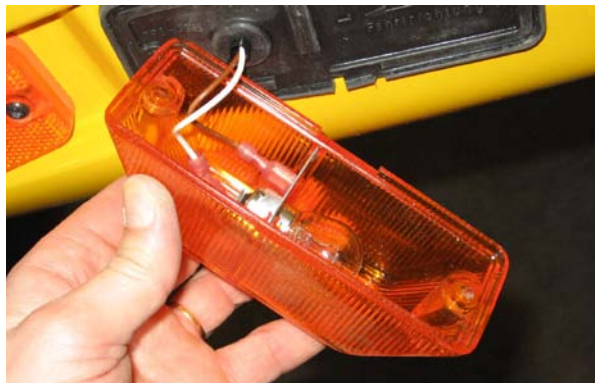

Picture 7-7

1. Unscrew the cap of the fitting (see *Picture 7-7*);
2. Replace the lamp;
3. Check the operation of the lamp;
4. Mount the cap on the fitting.

## 7.4.3. Rear direction indicator

### Replacing lamp

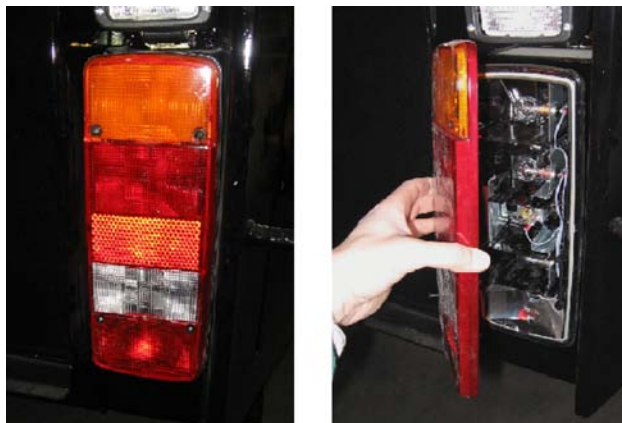

Picture 7-8

1. Unscrew the cap of the fitting (see *Picture 7-8*);
2. Replace the lamp;
3. Check the operation of the lamp;
4. Mount the cap on the fitting.

#### 7.4.4. Direction indicators buffer beam

There are extra direction indicators mounted on the buffer beam (see *Picture 7-9*).

##### Replacing lamp



*Picture 7-9*

1. Unscrew the grate;
2. Unscrew the cap of the fitting;
3. Replace the lamp;
4. Check the operation of the lamp;
5. Mount the cap on the fitting;
6. Mount the grate.

#### 7.5. Tail light

##### 7.5.1. Tail light truck

##### Replacing lamp

Replacing the tail lights follows the same procedure as replacing the rear direction indicator (see § 7.4.3. *Rear direction indicator*).



### 7.5.2. Extra tail light on the tower

At the rear of the truck (on the tower of the crane) an extra tail light with integrated brake light is mounted (see *Picture 7-10*).



*Picture 7-10*

1. Unscrew the cap of the fitting;
2. Replace the lamp;
3. Check the operation of the lamp;
4. Mount the cap on the fitting.

### 7.5.3. Tail light buffer beam

#### **Replacing lamp**

Replacing the tail lights of the buffer beam follows the same procedure as replacing the direction indicator of the buffer beam (see § 7.4.4. *Direction indicators buffer beam*).

### 7.6. Brake light

#### 7.6.1. Brake light truck

The brake lights of the truck are integrated in the tail light of the truck.

#### **Replacing lamp**

For more information, see § 7.5.1. *Tail light truck*.

#### 7.6.2. Extra brake light on the tower

The extra brake light on the tower of the crane is integrated in the extra tail light.

#### **Replacing lamp**

For more information, see § 7.5.2. *Extra tail light on the tower*.

### **7.6.3. Brake light buffer beam**

The brake lights of the buffer beam are integrated in the tail light of the buffer beam.

#### **Replacing lamp**

For more information, see § 7.5.3. *Tail light buffer beam*.

## **7.7. Reverse drive light**

### **7.7.1. Reverse drive light truck**

#### **Replacing lamp**

Replacing the reverse drive lights follows the same procedure as replacing the rear direction indicator (see § 7.4.3. *Rear direction indicator*).

### **7.7.2. Reverse dive light buffer beam**

#### **Replacing lamp**

Replacing the reverse drive light of the buffer beam follows the same procedure as replacing the rear direction indicator of the buffer beam (see § 7.4.4. *Direction indicators buffer beam*).

## **7.8. Fog tail light**

### **7.8.1. Fog tail light truck**

#### **Replacing lamp**

Replacing the fog tail light follows the same procedure as replacing the rear direction indicator (see § 7.4.3. *Rear direction indicator*).

### **7.8.2. Fog tail light buffer beam**

#### **Replacing lamp**

Replacing the fog tail light of the buffer beam follows the same procedure as replacing rear direction indicator of the buffer beam (see § 7.4.4. *Direction indicators buffer beam*).

## 7.9. Side marking lights

### 7.9.1. Side marking light truck

#### Replacing lamp

This side marking lights contains LED's which are not replaceable (see *Picture 7-11*).

If this light is defective, the entire unit needs to be replaced.



*Picture 7-11*



*Picture 7-12*

1. Unscrew the side marking light (Torx screws);
2. Remove the connector (see *Picture 7-12*);
3. Replace the side marking unit by a new one;
4. Check the operation of the lamp;
5. Mount the new side marking unit.

## 7.9.2. Side marking light buffer beam

### Replacing lamp



Picture 7-13

1. Unscrew the cap of the fitting (see *Picture 7-13*);
2. Replace the lamp;
3. Check the operation of the lamp;
4. Mount the cap on the fitting.

## 7.10. Contour lights

### 7.10.1. Front contour lights

At the right-hand side of the vehicle, the contour lights are attached to the de tower head box; at the front left-hand side the contour lights are attached to the top jib (see *Picture 7-14*).

### Replacing lamp

The contour lights at the front contain LED's, which are not replaceable.

If this light is defective, the entire unit needs to be replaced (see *Picture 7-14*).

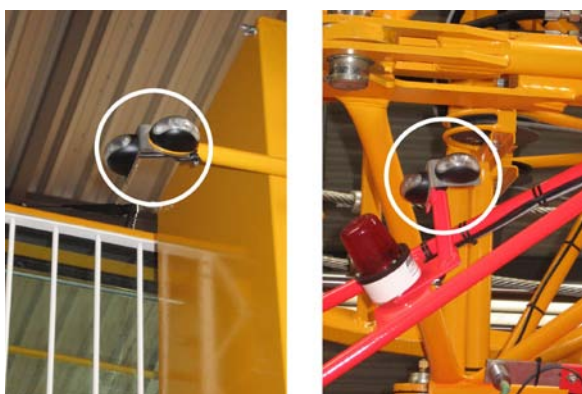

Picture 7-14

1. Loosen the contour light (two nuts at the rear);
2. Remove the connector;
3. Replace the defective contour light by a new one;
4. Check the operation of the lamp;
5. Mount the new contour light.

### 7.10.2. Rear contour light

The rear contour lights are mounted to the platform of the crane (see *Picture 7-15*).

#### Replacing lamp



*Picture 7-15*

1. Unscrew the cap of the fitting;
2. Replace the lamp;
3. Check the operation of the lamp;
4. Mount the cap on the fitting.

## 7.11. License plate lights

The license plate at the rear of the truck is illuminated (see *Picture 7-16* and *Picture 7-17*).

### Replacing lamp



*Picture 7-16*



*Picture 7-17*

1. Unscrew the cap of the fitting;
2. Replace the lamp;
3. Check the operation of the lamp;
4. Mount the cap on the fitting.

## 7.12. Rotaflares

The truck is equipped with a number of rotaflares (see *Picture 7-18*).



*Picture 7-18*

### Replacing lamp

The orange cap is firmly clamped under a clamp edge.

1. Pull the orange cap gently of the fitting;
2. Replace the lamp;
3. Check the operation of the lamp;
4. Mount the orange cap on the fitting.

### 7.13. Work lamps

There are two types of work lamps mounted on the truck. The first type work lamp (see *Picture 7-19*) is mounted to the engine cowling, above the tail lights and at the outrigger beams.

The second type, the Xenon lamp (see *Picture 7-20*), is mounted at the lower side of the tower.



*Picture 7-19*

#### Replacing lamp

1. Unscrew the cap of the fitting;
2. Replace the lamp:
  - Remove the cables;
  - Release the clamping spring and turn it away from the lamp base;
  - Replace the lamp;
  - Mount the clamping spring;
  - Connect the cables;
3. Check the operation of the lamp;
4. Mount the cap on the fitting.

The second type is a Xenon lamp. If this lamp is defective, the entire unit must be replaced. It is the easiest way for replacing if the tower is standing vertically as shown in *Picture 7-20*.



*Picture 7-20*



## 8. Hydraulic system



### CAUTION!

The hydraulic system is under high pressure (up to  $\pm 400$  bar).



### INFORMATION!

For more information, see the hydraulic diagram in the Annex.



### CHECK / TEST!

Timely check all components of the hydraulic system for damage and/or leaks to prevent damage to the hydraulic system.

For service intervals, see § 5.2.6. *Maintenance schedule hydraulic system truck.*

All hoses, connections, hydraulic blocks, filters, cylinders and the oil tank must be regularly checked on damage and leakage.

Repair damage and/or leakage as soon as possible to prevent major damage to the hydraulic system.

### 8.1. Hydraulic tank

The hydraulic tank is situated in the chassis (*Picture 8-1*) and can be reached via the manhole of axle 2 (when the axles are fully pushed out).

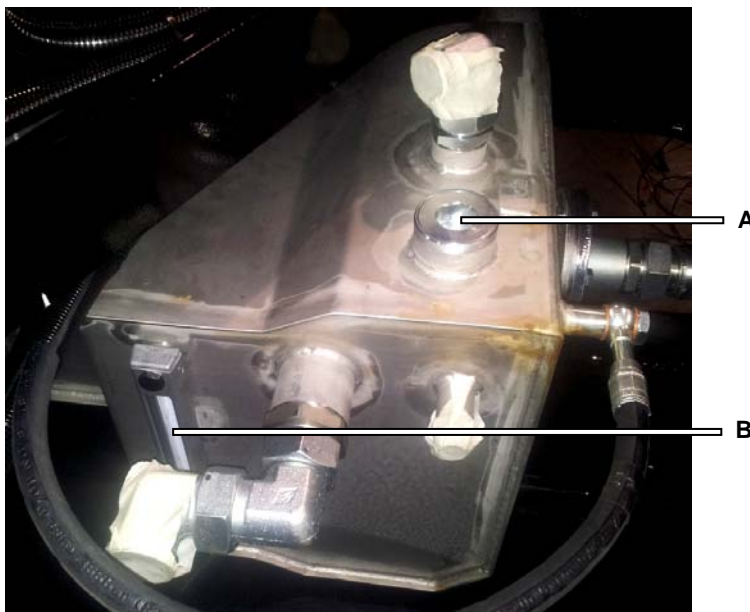

*Picture 8-1*

### 8.1.1. Checking oil level

#### CHECK / TEST!



Timely check the hydraulic oil level to prevent damage to the system.

For more information, see § 5.2.6. *Maintenance schedule hydraulic system truck.*

#### CONDITIONS



- The truck must be standing horizontally;
- The oil temperature must be below 40 °C;
- All axles must be fully retracted;
- The outriggers and outrigger beams must be fully retracted;
- The axle blocking may not be enabled.

Check the oil level:

1. Check by means of the *sight glasses B (Picture 8-1)* of the oil tanks if the oil level reaches the top of the sight glasses;
2. Top up the hydraulic tank, if necessary (see § 8.1.2. *Topping up oil*).

### 8.1.2. Topping up oil

#### INFORMATION!



Always top up hydraulic oil with oil of the same brand and type (see § 14.4. *Specifications hydraulic system truck*).

Top up with hydraulic oil via the filler neck of the tank (*Picture 8-1, A*).

The oil may reach maximally to the upper edge of the sight glasses.

### 8.1.3. Analysing oil

#### CHECK / TEST!



After 5 years, have the oil analysed after refreshing.  
Then have the oil analysed every 2 years.

Have the hydraulic oil regularly analysed and refresh the hydraulic oil if needed.

#### 8.1.4. Refreshing oil

##### CONDITIONS



- The truck must be standing horizontally;
- The oil temperature must be below 40 °C;
- All axles must be fully retracted;
- The outriggers and outrigger beams must be fully retracted;
- The axle blocking may not be enabled.

Refresh the hydraulic oil:

1. Open the *filler cap A* of the hydraulic tank (see *Picture 8-1*);
2. Place an oil tray under the drainage point *hose tank emergency steering pump* (see *Picture 8-2*), which is situated beneath the superstructure slewing rim;

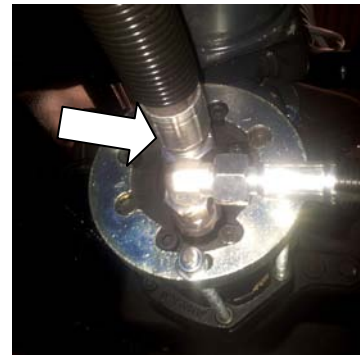

Picture 8-2

3. Unscrew the *hose tank emergency steering pump* (see arrow in *Picture 8-2*) and let the oil leak from all compartments of the hydraulic tank;
4. Mount the *hose tank emergency steering pump* with a new sealing ring;
5. Refill the hydraulic tank with new hydraulic oil (see § 8.1.2. *Topping up oil* and § 14.4. *Specifications hydraulic system truck*);
6. Mount *filler cap A* on the hydraulic tank.

#### 8.2. Hydraulic pumps

Two hydraulic pumps are driven by the truck engine. The steering pump (mounted in the lower left corner against the engine block) provides the mechanically steered front axles with hydraulic oil. The other pump is mounted on the flywheel housing and provides the rear axle, the suspension system and the outrigger system with hydraulic oil.

#### 8.3. Filters

There are three filters present in the hydraulic system, which need to be replaced according to § 5.2.6. *Maintenance schedule hydraulic system truck*.

The following sections describe the filters mentioned below:

- Hydraulic fine filter;
- Hydraulic coarse filter;
- Hydraulic fine filter at rear axle steering.

### 8.3.1. Replacing the hydraulic fine filter



#### CHECK / TEST!

Timely replace the hydraulic fine filter to prevent damage to the hydraulic system. For more information, see § 5.2.6. *Maintenance schedule hydraulic system truck.*

The hydraulic fine filter (*Picture 8-3*) is situated in the left-hand engine cowling.



Picture 8-3

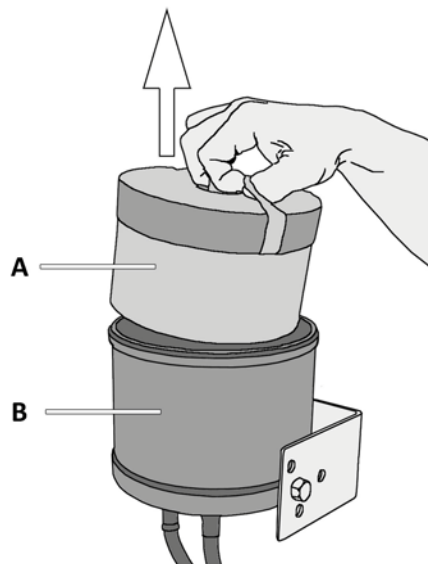

Picture 8-4

Replace the hydraulic fine filter (see *Picture 8-4*):

1. Erect the crane until the tower is vertically positioned and secured;
2. Remove the left-hand cover plate of the engine cowling;
3. Unscrew the lid of the *filter holder B* by turning the lever counterclockwise;
4. Replace the *filter element A* and the sealing rings, which must be greased lightly;
5. Mount the lid of the filter holder and screw it tightly by hand;
6. Start the engine and let it run for a few minutes;
7. Check the oil level (see § 8.1.2. *Topping up oil*);
8. Check for leakage;
9. Mount the removed cover plate;
10. Fold the crane.

### 8.3.2. Replacing the hydraulic coarse filter

**CHECK / TEST!**



Timely replace the hydraulic coarse filter to prevent damage to the hydraulic system.

For more information, see § 5.2.6. *Maintenance schedule hydraulic system truck.*

The hydraulic coarse filter (Picture 8-5) is situated in the left-hand engine cowling.



Picture 8-5

Replace the hydraulic coarse filter:

1. Erect the crane till the tower is vertically positioned en secured;
2. Remove the left-hand cover plate of the engine cowling (see § 2.4. *Engine cowling*);
3. Replace the filter:
  - Rotate the filter using a strap wrench;
  - Lightly grease the sealing ring of the new filter;
  - Mount the new filter and screw it tightly by hand;
4. Start the engine and let it run for a few minutes;
5. Check the oil level (see § 8.1.1. *Checking oil level*) and top up if necessary (see § 8.1.2. *Topping up oil*);
6. Check for leakage;
7. Mount the removed cover plate;
8. Fold the crane.

### 8.3.3. Replacing the hydraulic fine filter at rear axle steering

The hydraulic system of the rear axle steering is equipped with a hydraulic fine filter.  
The fine filter is located in the left-hand engine cowling (see *Picture 8-6*).



Picture 8-6

#### INFORMATION!



Replace this fine filter once per 5 years when the coarse filter is removed, related to limited working space.

For replacing the hydraulic fine filter, the following steps must be carried out:

1. Turn off the diesel engine of the truck;
2. Place an oil tray under the filter;
3. Unscrew the bottom of the filter (wrench width 19);
4. Remove the filter from the holder;
5. Clean the holder, if necessary, with a lint-free dry cloth;
6. Replace the O-ring by a new one, which is lightly greased (see § 14.4. *Specifications hydraulic system truck*);
7. Replace the fine filter by a new one (see § 14.4. *Specifications hydraulic system truck*);
8. Mount the bottom of the fine filter.

If there are problems with the rear axle steering, the hydraulic fine filter should be checked.

For more information, see § 5.2.6. *Maintenance schedule hydraulic system truck*.

## 9. Pneumatic system

The pneumatic system consists of a primary and a secondary system (see the pneumatic diagram in the Annex). The *primary system* is composed of two circuits, which are intended for the brakes of the truck. The *secondary system* is intended for the parking brake, gear box and accessories and is also composed of two circuits.

The air pressure is supplied by a compressor, which is mounted on the engine. The pneumatic system is secured by a safety valve. If there is a leak in one of the four circuits causing the elimination of the air pressure, this safety valve ensures that the other three circuits remain their air pressure.

### 9.1. Primary system: the brakes

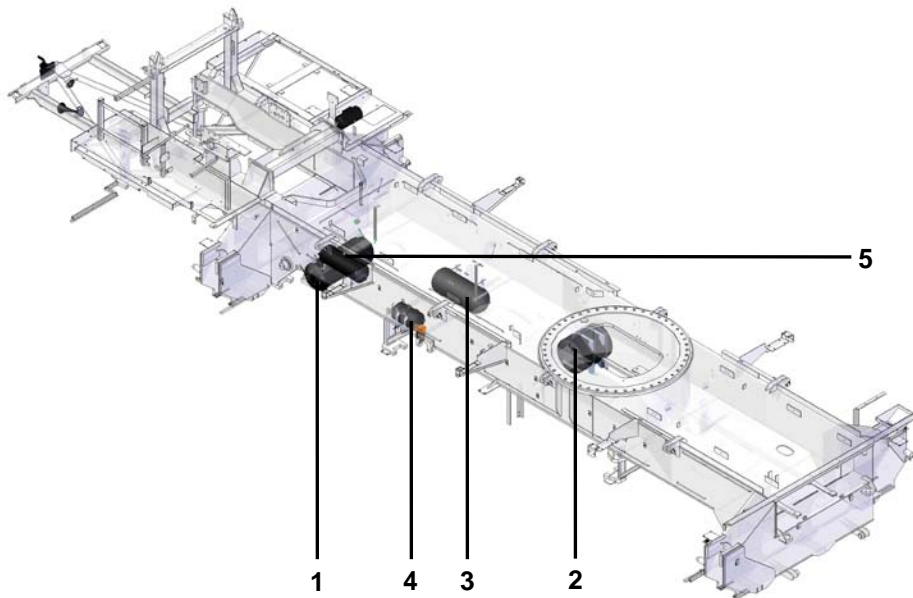

Picture 9-1

The brake system consists of three compressed air reservoirs (see *Picture 9-1*):

- **Compressed air reservoir 1** (60 litres):
  - This reservoir ensures the operating of the (service) brake boosters of axles 1 and 2;
  - This reservoir also provides the compressed air for operating the relays for the benefit of the (service) brake boosters of axles 1 and 2 by means of the foot brake pedal;
- **Compressed air reservoir 2** (60 litres):
  - This reservoir ensures the operating of the (service) brake boosters of axles 3, 4 and 5;
  - This reservoir also provides the compressed air for operating the relays for the benefit of the (service) brake boosters of axles 3, 4 and 5 by means of the foot brake pedal;
- **Compressed air reservoir 3** (40 litres):
  - This reservoir ensures the operating of the (service) brake boosters of axles 2, 3 and 4;
  - This reservoir also provides the compressed air for operating the relays for the benefit of the (service) brake boosters of axles 2, 3 and 4 by means of the parking brake lever.

The parking brake is venting based. As soon as the brake lever is operated, the parking brake boosters on axles 2, 3 and 4 will be vented, causing the brakes to start performing.

## 9.2. Secondary system

The secondary system is composed of two compressed air reservoirs (see *Picture 9-1*):

- **Compressed air reservoir 4** (10 litres):
  - This reservoir ensures the air pressure for all secondary components (accessories);
- **Compressed air reservoir 5** (20 litres):
  - This is an emergency reservoir for the clutch and the gear box. If the air pressure in the secondary system is lost, still the clutch and the gear box can be switched for a few times.

The following components are operated by the secondary system:

- Engine brake:
  - Close/open exhaust valve;
  - Enable/disable fuel pump;
- Gear box:
  - Power supply various features gear box and retarder;
- Transfer case:
  - Switch between on-the-road mode / off-the-road mode;
  - Switch longitudinal differential lock axle 3;
  - Switch towing position;
- Axles:
  - Switch transversal differential lock axles 2, 3 and 5;
- EAS-system:
  - Supply control AdBlue;
- Cab:
  - Air suspension driver's seat.

The pressure reducing valve for the components of the secondary circuit is adjusted to 5.5 bar.



### 9.3. Air dryer



**CHECK / TEST!**

Replace the air dryer filter every two years at normal operating conditions.

To extend the service life of the components and to ensure proper functioning, the pneumatic system is provided with an air dryer.

The air dryer is situated in the right-hand engine cowling (see *Picture 9-2*).

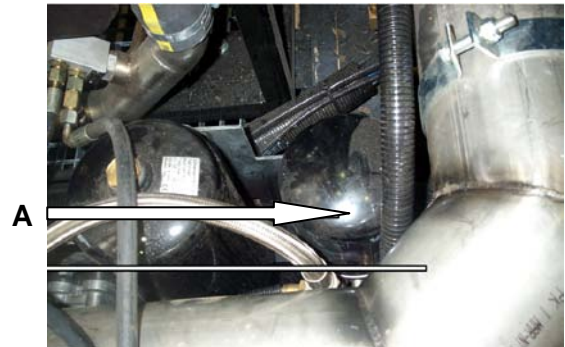

*Picture 9-2*

#### 9.3.1. Replacing filter air dryer

1. Erect the crane till the tower is vertically positioned and secured;
2. Turn off the engine of the truck;
3. Depressurize the pneumatic system:
  - Release the pressure by using a hose connected to *nipple A* above the right-hand outrigger beam (see *Picture 9-3*);

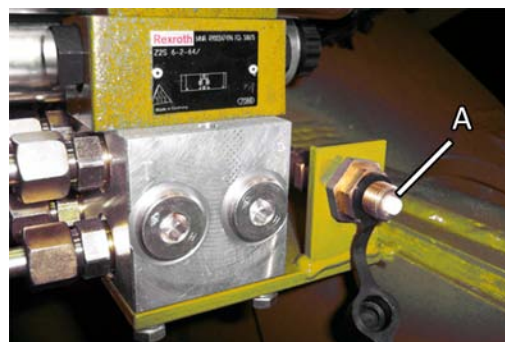

*Picture 9-3*

4. Remove the central cover plate of the engine cowling:
  - The filter element is located at *Picture 9-2, A*;
5. Unscrew the filter element (see *Picture 9-2, A*) of the air dryer using a strap wrench;
6. Lightly grease the sealing of the new filter element;
7. Mount the new filter element on the filter holder and tighten it by hand;
8. Turn on the ignition and check for leakage;
9. Mount the cover of the engine cowling.

## 9.4. Compressed air reservoirs



### CHECK / TEST!

Check the compressed air reservoirs every 2 months for condensed water.

Check the compressed air reservoirs for condensed water by pressing the de-watering valve at the bottom of the reservoirs (see *Picture 9-4*). If there is condensed water frequently, then the element of the dryer needs to be replaced.



Picture 9-4

## 9.5. Oil atomizer / water separator



### CHECK / TEST!

Check the level of the oil atomizer and de-water the water separator every 2 months at normal operating conditions.

The oil atomizer / water separator (*Picture 9-5*) is situated against the accessory reservoir, under the chassis at the left between axles 3 and 4.

The oil atomizer / water separator is composed of the following parts:

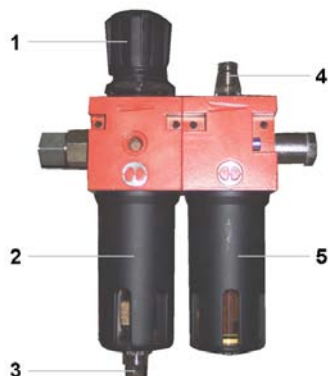

Picture 9-5

1. Pressure reducing valve;
2. Water separator;
3. Water separator valve;
4. Adjusting screw oil atomizer;
5. Reservoir oil atomizer.

### 9.5.1. Topping up oil atomizer

1. Make sure the diesel engine is not running;
2. Turn the *flask 5* (Picture 9-5) from the holder and top up the oil until the maximum level is reached (see § 14.5. *Specifications pneumatic system*).
3. Turn the flask with oil back into the holder;
4. Adjust the amount of sprayed oil by means of the *adjusting screw 4*.

### 9.5.2. Performance water separator

The water separator is operating semi-automatically. If there is pressure on the air system, the valve under the water separator will be pressed in. The condensate will be collected in the flask.  
If there is no pressure on the air system, the valve will be opened and the condensate will drain off.

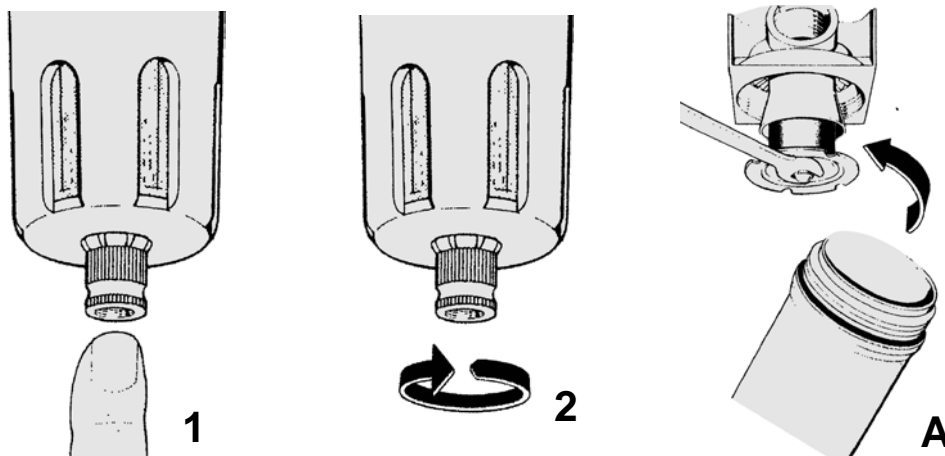

Picture 9-6

- Press the valve to remove the condensate manually (see *Picture 9-6, 1*);
- Turn the valve clockwise to close it permanently (*2*).

### 9.5.3. Replacing element water separator

For replacing or cleaning the filter element, the screw of the filter element must be loosened by means of a special wrench (see *Picture 9-6, A*).

### 9.5.4. Adjusting air pressure secondary air circuit

The pressure of the secondary air circuit (5.5 bar) can be adjusted by means of the pressure reducing valve of the water separator.

For the values of these pressures, see the pneumatic diagram in the Annex.

## 9.6. Checking brake pressure



### CHECK / TEST!

Check the brake pressure of all axles during the annual maintenance.

### 9.6.1. Pressure brake boosters

- Brake boosters axles 1, 2 and 3: 8.5 bar;
- Brake boosters axles 4 and 5: 7.5 bar.

The pressures can be adjusted by two pressure reducing valves, which are mounted in the control lines.

Check the system pressure at a running engine. This can be done by connecting a calibrated air pressure on one of the 60 litres air pressure reservoirs. These are mounted in the chassis under the truck cab (see *Picture 9-7, 1*) and between axle 3 and axle 4 (see *Picture 9-7, 2*).

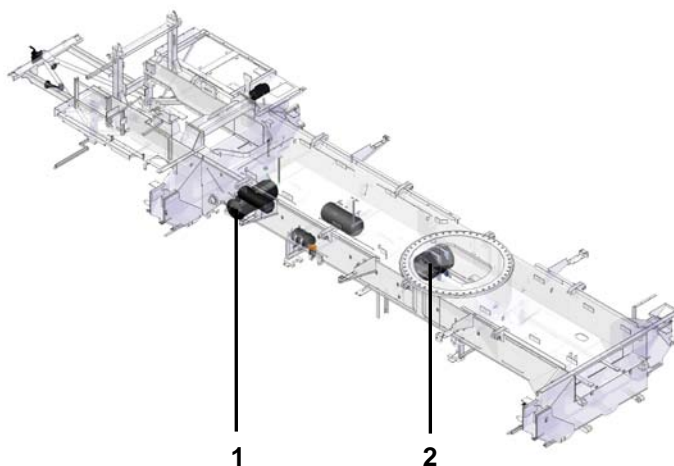

Picture 9-7

The system pressure must be 9.8 bar and can be adjusted by the pressure relief valve on the air dryer. There are measurement connections mounted on the brake boosters of all axles.

## 9.7. Hoses and connections pneumatic system



### CHECK / TEST!

Check all components of the pneumatic system every 2 months for leakage and damage.

All hoses, connections, pneumatic valve blocks, filters, cylinders and compressed air reservoirs must be checked regularly for leakage and damage.

In case of leakage and/or damage, replace the component as soon as possible to prevent major damage.

## 10. Diesel engine truck

The warranty documents of the diesel engine are supplied separately.

### 10.1. Specifications diesel engine truck

The truck is provided with a DAF turbo diesel with intercooler (see *Picture 10-1*).

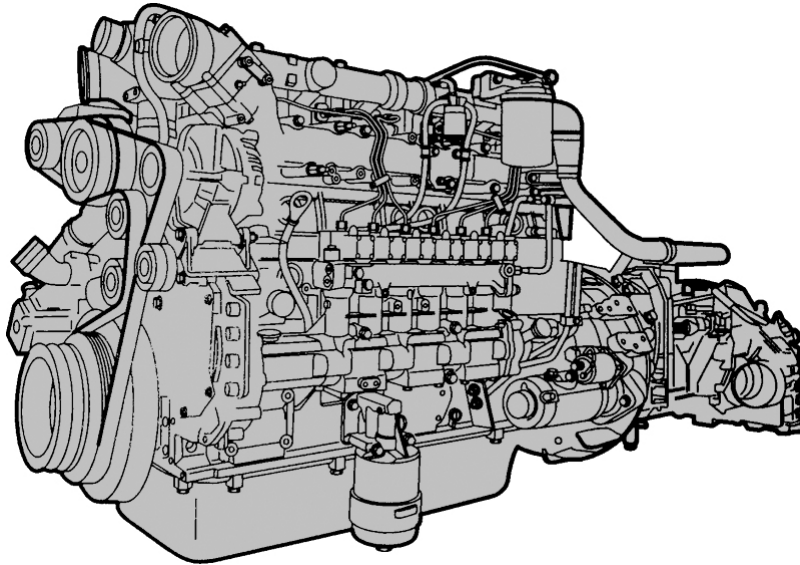

*Picture 10-1*

#### Technical data

Brand and model	DAF MX375
Version	Water cooled four-stroke diesel engine with electronically controlled injection system
Number of cylinders	6
Number of valves per cylinder	4
Fuel system	Common-rail
Volume fuel tank	600 litres (+ 60 litres buffer tank)
Volume AdBlue-tank	75 litres
Intake system	Turbo-Intercooler
Swept volume	12.9 litres
Maximum power	375 kW at 1,900 rpm
Maximum torque	2.500 Nm at 1,000 - 1,410 rpm
Compression ratio	16.5 : 1
Bore x Stroke	130 x 162 mm
Idling speed without load	Approx. 550 rpm
Maximum engine speed (loaded)	1,900 rpm (limited)

### Engine number

The number of the engine is situated on the right side of the engine at the water pump casing (see *Picture 10-2*).

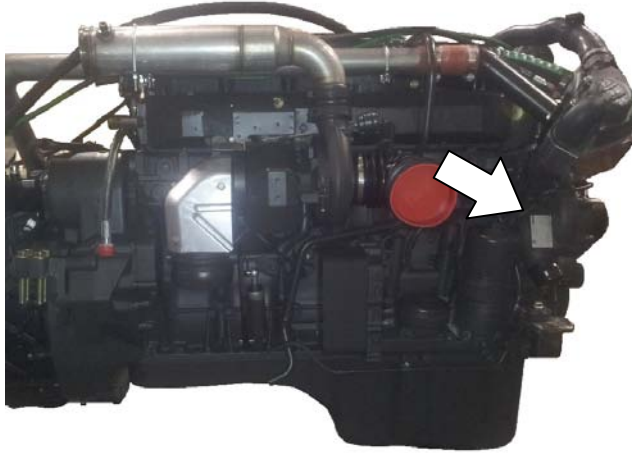

*Picture 10-2*

## 10.2. Engine oil diesel engine truck



### TOXIC SUBSTANCES!

Lubrication oil can cause skin irritation or skin lesions.



Avoid contact with the lubricating oil to prevent skin lesions.



When working with lubricating oil, wear protective clothing, gloves and eye protection.



### CAUTION!

Always use oil with specifications as listed in § 14.1. *Maintenance specifications*. Only top up oil with the same type and brand.

### 10.2.1. Checking oil level diesel engine truck



### CHECK / TEST!

Timely check the oil level to prevent damage to the engine.  
For maintenance see § 5.2.1. *Maintenance schedule diesel engine truck*.

The oil level must be between *Min* and *Max* level.

### 10.2.1.1. Checking oil level on the main screen

The main screen shows a bar, which represents the oil level. However, checking the oil level this way is only reliable with an oil temperature above 55 °C.

Is the temperature of 55 °C only just reached, let the engine run for 8 minutes before reading the oil level (see § 3.9.2.3. *Main screen: Information screen*).

Top up oil, if necessary (see § 10.2.2. *Topping up oil diesel engine truck*).

At a temperature lower than 55 °C or in case of doubt, it is recommended to check the oil level by means of a dipstick.



#### CHECK / TEST!

Spierings Mobile Cranes recommends to check the oil level using a dipstick.

### 10.2.1.2. Checking oil level by means of a dipstick

The oil level can also be checked by means of a dipstick.



#### CONDITIONS

- The vehicle must stand on a flat horizontal surface;
- Last time the engine was running, it must have reached an oil temperature of at least 80 °C;
- The waiting period (ignition off) must be at least 15 minutes since the last engine stop, so the oil can run down the crankcase.



Picture 10-3

Checking the oil level using the dipstick, must be carried out as follows:

1. Open the cover of the left-hand engine cowling;
2. Take the dipstick (*Picture 10-3, A*) out of the holder at the left-hand side of the electrical cabinet;
3. Clean the dipstick using a clean lint-free cloth;
4. Insert the dipstick fully back into the holder and take it out again;
5. Check if the oil level is between *Min* and *Max* (*B*);
6. Insert the dipstick back into the holder;
7. Top up oil, if necessary (see § 10.2.2. *Topping up oil diesel engine truck*);
8. Close the cover of the engine cowling (see § 2.4. *Engine cowling*).

### 10.2.2. Topping up oil diesel engine truck

Topping up oil must be done according the following steps.



Picture 10-4

1. Open the cover of the left-hand engine cowling (see § 2.4. Engine cowling);
2. Switch the filler neck for some 90 ° (see Picture 10-4);
3. Turn off the cap of the filler neck;
4. Top up dosed oil (see § 14.1. Maintenance specifications);
5. Wait for a few minutes, so the oil can run down the crankcase;
6. Check the oil level using the dipstick (see § 10.2.1. Checking oil level diesel engine truck);
7. Check if the oil level is between *Min* and *Max (B)*;
8. Insert the dipstick back into the holder;
9. Top up oil, if necessary and repeat item 5 and 6, if necessary;
10. Close the filler neck by using the cap;
11. Close the cover of the engine cowling (see § 2.4. Engine cowling).

#### INFORMATION!



When topping up large quantities of oil (e.g. at refreshing the oil), it is recommended to fill the crankcase by using the filler neck on top of the engine (see Picture 10-5). Therefore, remove the central cover plate of the engine cowling.



Picture 10-5



### 10.2.3. Refreshing oil diesel engine truck

#### CHECK / TEST!



Timely refresh the oil to prevent damage to the engine.  
For more information, see § 5.2.1. *Maintenance schedule diesel engine truck.*  
When refreshing the oil, always replace the oil filter element immediately.

#### 10.2.3.1. Draining oil

#### CAUTION!



Draining oil may only be carried out when the engine is turned off.  
The engine may not be started until the crankcase is sufficiently filled with oil again. Drained oil may be hot!

#### CONDITIONS



- The vehicle must stand on a flat horizontal surface;
- The engine should preferably be warm.

Draining oil must be carried out as follows.

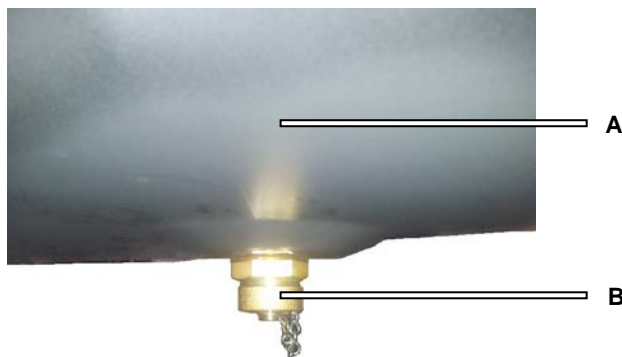

Picture 10-6

1. Place an oil tray (of sufficient size) under the drain plug (Picture 10-6);
2. Remove *drain plug B* from the *crankcase A*;
3. Let the oil drain from the crankcase;
4. Replace the copper sealing ring of the drain plug by a new one;
5. Mount the drain hose on the front drain plug on the crankcase:
  - Immediately the oil begins to flow into the oil tray;
6. Remove the drain hose;
7. Replace the oil filter element (see § 10.2.3.2. *Replacing oil filter element*);

### 10.2.3.2. Replacing oil filter element

#### INFORMATION!



When replacing the new filter element, minimize touching the filter. Touching the filter element may affect the operation of the filter and shorten the service life.

The oil filter is situated at the right side of the engine.

Replacing the filter element (*Picture 10-7*) must be carried out as follows:



*Picture 10-7*

1. Place an oil tray (of sufficient size) under the filter element;
2. Rotate the filter cover a few times and let the filter casing leak off;
3. Remove the filter cover with the filter element from the filter casing;
4. Remove the filter element out of the filter cover;
5. Replace the O-ring and lightly grease the new one;
6. Mount a new filter element (see § 14.1. *Maintenance specifications*);
7. Mount the filter cover back on the filter casing;
8. Tighten the filter cover with the tightening torque, which is mentioned on the filter cover;
9. Top up the engine with oil (see § 10.2.2. *Topping up oil diesel engine truck*).

### 10.2.3.3. Topping up oil

Topping up the engine with oil must be done as mentioned below:

1. Remove the central cover plate of the engine cowling;
2. Top up the crankcase with oil (see § 10.2.2. *Topping up oil diesel engine truck*);
3. Close the filler neck by using the cap;
4. Start the engine and let it run for a few minutes;
5. Check the filter casing for leakage;
6. Mount the central cover of the engine cowling (see § 2.4. *Engine cowling*);
7. Fold the crane.

### 10.3. Cooling system diesel engine truck

#### CHECK / TEST!



Check the cooling system timely for leaks on hoses, pipes, connections and also on damage to the radiator, intercooler, oil cooler and fan.

For more information, see § 5.2.1. *Maintenance schedule diesel engine truck.*

#### CAUTION!



Always use the coolant as mentioned in § 14.1. *Maintenance specifications.*  
Only top up with coolant of the same type.

#### CORROSIVE SUBSTANCES!



Coolant is a harmful substance.  
When working with coolant, wear eye and skin protection.



When handling coolant, wear protective clothing, gloves and eye protection.



#### 10.3.1. Checking coolant level diesel engine truck

#### CHECK / TEST!



Timely check the coolant level to prevent damage to the engine.

For more information, see § 5.2.1. *Maintenance schedule diesel engine truck.*

#### CAUTION!



Never unscrew the cap of the filler neck of the expansion tank if the engine is warm.  
Hot coolant is under pressure and may be sprayed when unscrewing the cap!

#### CONDITIONS



The engine must be cold.

Checking the coolant level must be done as mentioned below.



Picture 10-8

1. Turn off *cap A* (Picture 10-8) of the expansion tank;
2. Check if the coolant reaches the edge of the filler neck;
3. Top up coolant, if necessary (see § 10.3.2. *Topping up coolant diesel engine truck*);
4. Close the filler neck by using the cap.

### 10.3.2. Topping up coolant diesel engine truck

#### CAUTION!



Never unscrew the cap of the filler neck of the expansion tank if the engine is warm.  
Hot coolant is under pressure and may be sprayed when unscrewing the cap!



#### CONDITIONS

The engine must be cold.

1. Turn off *cap A* (Picture 10-8) of the expansion tank;
2. Top up the expansion tank with coolant, until the fluid level reaches the edge of the filler neck (see § 14.1. *Maintenance specifications*);
3. Turn on the heating in the truck cab at maximum temperature:
  - This causes the heater valve to be fully opened;
4. Start the engine;
5. Top up coolant if the level drops. Keep checking during the time the engine is running:
  - Let the engine run to warm up; if the operating temperature is reached, the thermostat will be opened;
6. Stop the engine if the coolant level is not lowering anymore;
7. Close the filler neck by using the cap.

### 10.3.3. Refreshing coolant diesel engine truck

#### CHECK / TEST!



Timely check the coolant level to prevent damage to the engine.  
For more information, see § 5.2.1. *Maintenance schedule diesel engine truck.*

#### CAUTION!



Never unscrew the cap of the filler neck of the expansion tank if the engine is warm.  
Hot coolant is under pressure and may be sprayed when unscrewing the cap!

#### CONDITIONS



The engine must be cold.

1. Remove the cap A of the expansion tank (see *Picture 10-8*);
2. The drain plug for the coolant is situated in the centre beneath the cabine (see *Picture 10-10*);

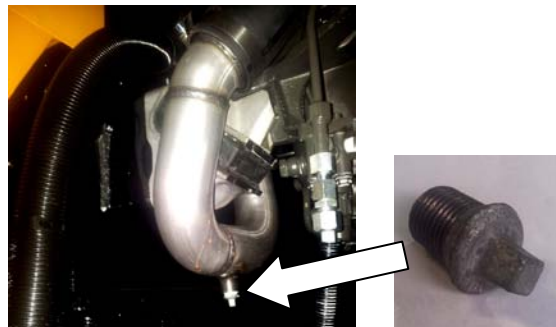

*Picture 10-9*

3. Put an oil tray under the drainage plug at the at the bottom of the piping (see arrow);
4. Unscrew the drainage plug and let the coolant drain;
5. Mount the drainage plug to the bottom of the radiator is there is no oil leaking anymore;
6. In the same way, let the coolant drain out of the drainage point of the oil cooler (see *Picture 10-10*) at the right side of the engine;
7. Mount all opened drainage plugs, except the filler neck of the expansion tank;
8. Top up the cooling system with coolant (see § 10.3.2. *Topping up coolant diesel engine truck*);
9. Close the filler neck of the expansion tank by using the cap.

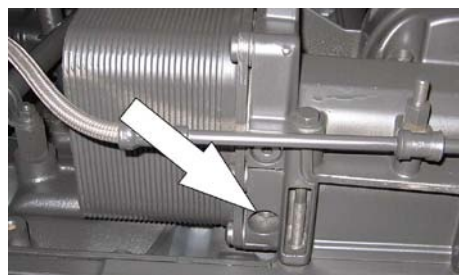

*Picture 10-10*

#### 10.3.4. Anti-freeze concentration

**CHECK / TEST!**



Timely check the anti-freeze concentration of the coolant to prevent damage to the engine.  
For more information, see § 5.2.1. *Maintenance schedule diesel engine truck.*



**CAUTION!**

Never add anti-freeze to the coolant!

It is recommended to check the anti-freeze concentration of the coolant before the winter season starts. The coolant must handle a minimum temperature of -32 °C. Refresh the coolant if the measured values fail (see § 10.3.3. *Refreshing coolant diesel engine truck.*).

#### 10.3.5. Cleaning radiator diesel engine truck

**CHECK / TEST!**



Check the radiator, intercooler and oil cooler timely on pollution, deposits, damage and leaks to prevent damage to the engine.  
For more information, see § 5.2.1. *Maintenance schedule diesel engine truck.*



**SAFETY GLASSES REQUIRED!**

Wear eye protection while cleaning the radiator.

1. Remove the central cover plate of the engine cowling.  
There are two ways of cleaning the radiator (see following sections).

##### 10.3.5.1. Cleaning the radiator with compressed air

The outside of the radiator is most easy to clean with compressed air (low pressure):

2. Always blow the fins clean in the longitudinal direction to prevent damage;
3. Mount the central cover plate of the engine cowling.

### 10.3.5.2. Cleaning the radiator with water

**CAUTION!**



- **NEVER** clean the radiator with high pressure!
- **Avoid contact with the electrical system when cleaning the radiator with water.**

The outside of the radiator can also be cleaned with water.

Preferably use a special cold aluminium cleaning agent:

2. Remove the radiator;
3. Let the aluminium cleaning agent rinse for a few minutes and wash away with a converging water jet in the longitudinal direction of the fins to prevent damage;
4. Mount the radiator and the central cover plate on the engine cowling.

### 10.3.6. Air intake system diesel engine truck

**CHECK / TEST!**



**Check the air intake system timely for leaks on hoses, pipes, connections to prevent reduced engine performance.**

**For more information, see § 5.2.1. *Maintenance schedule diesel engine truck.***

### 10.3.7. Cleaning air filter diesel engine truck



#### INFORMATION!

A contaminated air filter causes higher fuel consumption and loss of power.



#### CHECK / TEST!

Timely clean the air filter to prevent reduced engine performance.  
For more information, see § 5.2.1. *Maintenance schedule diesel engine truck.*



#### CONDITIONS

The engine must be turned off.

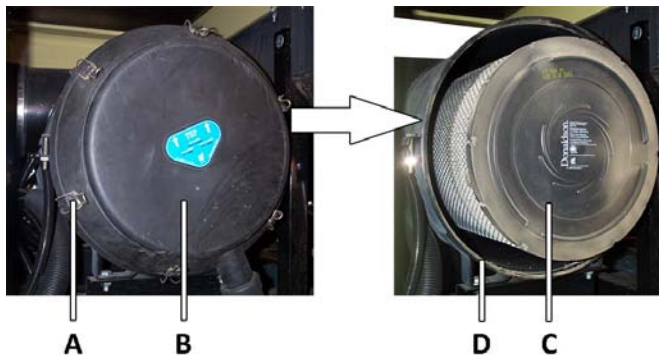

Picture 10-11

1. Remove the cover of the right-hand engine cowling;
2. Release all clips A (Picture 10-11) of the filter cover B and remove the filter cover from the filter casing D;
3. Remove the filter element C from the air filter casing;
4. Check the inner side of the filter casing and the filter cover for contamination and clean, if necessary;
5. Carefully beat the filter element (horizontal as in Picture 10-11) on a clean and dust-free surface:
  - Rotate the filter while beating, so the dust will be released through the openings;

#### CHECK / TEST!



Replace the filter element at damages to the sealing or to the filter element itself (see § 10.3.8. *Replacing air filter element diesel engine truck.*)

6. Lightly grease the rubber sealing ring of the filter element;
7. Mount the filter element in the filter casing;
8. Mount the filter cover to the filter casing and fasten the filter cover with clips A;
9. Close the cover of the engine cowling.



### 10.3.8. Replacing air filter element diesel engine truck

#### CHECK / TEST!



Timely replace the air filter element to prevent reduced engine performance.

For more information, see § 5.2.1. *Maintenance schedule diesel engine truck.*

#### INFORMATION!



When replacing the new filter element, minimize touching the filter.  
Touching the filter element may affect the operation of the filter and shorten the service life.

#### CONDITIONS



The engine must be turned off.

1. Remove the cover of the right-hand engine cowling;
2. Release all *clips A* (Picture 10-11) of the *filter cover B* and remove the filter cover from the *filter casing D*;
3. Remove the *filter element C* from the air filter casing;
4. Check the inner side of the filter casing for contamination and clean, if necessary;
5. Lightly grease the rubber sealing ring of the new filter element (see § 14.1. *Maintenance specifications*);
6. Mount the new filter element in the filter casing;
7. Mount the filter cover to the filter casing and fasten the filter cover with *clips A*;
8. Close the cover of the engine cowling.

### 10.4. Fuel system diesel engine truck



#### FIRE HAZARD!

Smoking and open flames prohibited!

#### CHECK / TEST!



Timely check the fuel system for leaks of hoses, pipes and connections to prevent dangerous situations.

For more information, see § 5.2.1. *Maintenance schedule diesel engine truck.*

#### 10.4.1. Checking fuel system

It is very important for the fuel system to be checked for any damage or leakage.

The entire system needs to be checked:

- Fuel tanks;
- Pipes;
- Fuel filter;
- Connections.

**CAUTION!**



It is important that both tanks are checked (buffer tank and fuel tank), but also the pipes between these tanks!

**CAUTION!**



If the engine gets no fuel, it is possible that the unit injectors are causing this problem.  
If this is the case, please contact Spierings Mobile Cranes.

#### 10.4.2. Fuel tanks

The truck is equipped with two fuel tanks (see *Picture 10-12*).

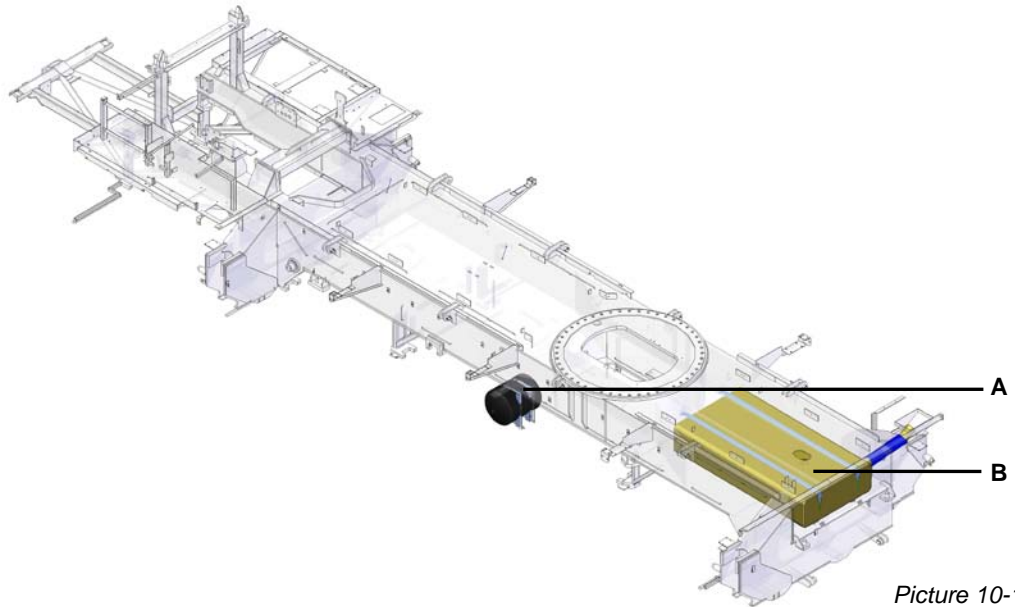

*Picture 10-12*

- A. Fuel tank;
- B. Buffer tank.

By means of the filler neck the tanks can be refilled. There is a buffer tank mounted between the fuel tank and the diesel engine. When uphill / downhill driving, this buffer tank ensures that no air can reach the fuel system of the diesel engine.

#### 10.4.3. Fuel pre-filter / water separator

The fuel pre-filter with water separator is situated in the slewing ring opening and can be reached from below (*Picture 10-13*).

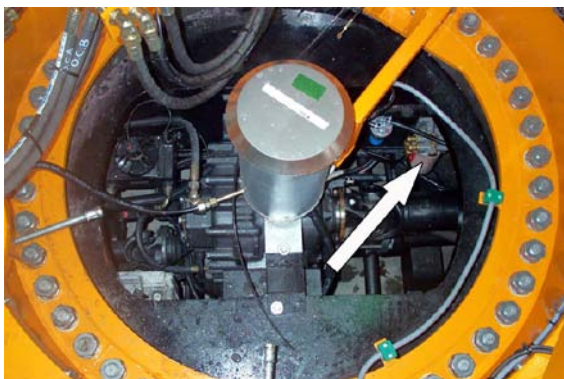

*Picture 10-13*

#### 10.4.3.1. Draining water separator

**CHECK / TEST!**



Regularly drain the water separator to prevent damage to the fuel system.

For more information, see § 5.2.1. *Maintenance schedule diesel engine truck.*

Draining the water separator (*Picture 10-14*) must be carried out as follows.

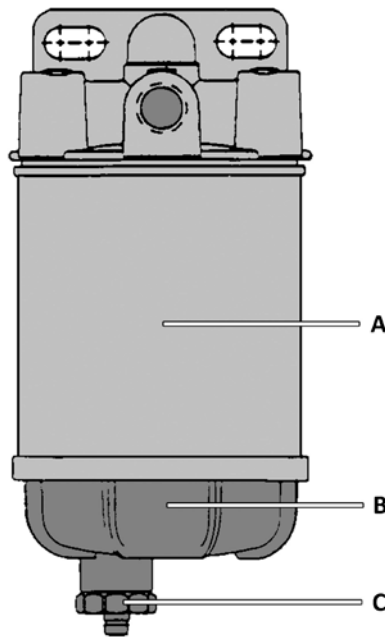

*Picture 10-14*

1. Partly open the *drainage plug C* (*Picture 10-14*) at the bottom of the water separator and let the water leak off;
2. Turn on the drainage plug as soon as the diesel comes out.

#### 10.4.3.2. Replacing fuel pre-filter / water separator

**CHECK / TEST!**



Timely replace the fuel pre-filter / water separator to prevent damage to the fuel system.

For more information, see § 5.2.1. *Maintenance schedule diesel engine truck.*

**INFORMATION!**



When replacing the new filter element, minimize touching the filter.

Touching the filter element may affect the operation of the filter and shorten the service life.

Replacing the fuel pre-filter / water separator (*Picture 10-15*) must be carried out as mentioned below.

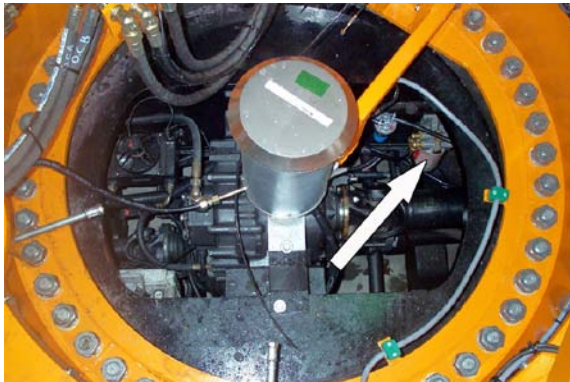

*Picture 10-15*

1. Put a tray under the filter;
2. Let the fuel out of the filter element by opening *drainage plug C* (*Picture 10-14*) at the bottom of the water separator;
3. Remove the *filter element A* (*Picture 10-14*) together with the *bottom cover B* (*Picture 10-14*) by turning it counterclockwise;
4. Remove the filter element from the bottom cover;
5. Clean the bottom cover;
6. Replace the O-ring and grease the new O-ring lightly;
7. Mount a new filter element on the bottom cover and fill with clean diesel;
8. Replace the sealing ring and lightly grease the new ring;
9. Mount the bottom cover together with the filter element on the filter casing:
  - Tighten the filter element by hand;
10. Vent the fuel system (see § 10.4.5. *Venting fuel system diesel engine truck*);
11. Start the engine and let it run for a few minutes;
12. Again tighten the filter element by hand;
13. Check the fuel system for leakage.

#### 10.4.4. Fuel filter diesel engine truck

The fuel filter is situated on the left-hand side of the diesel engine (*Picture 10-16*).

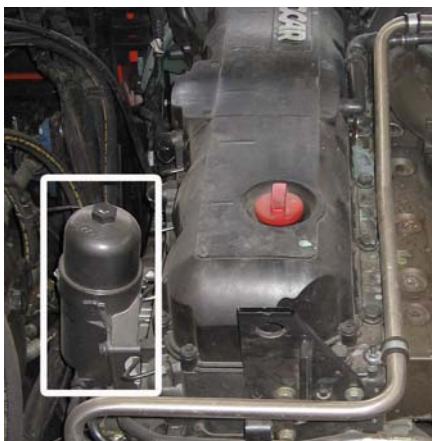

*Picture 10-16*

**CHECK / TEST!**



Timely replace the fuel filter to prevent damage to the engine.  
For more information, see § 5.2.1. *Maintenance schedule diesel engine truck.*

**INFORMATION!**



When replacing the new filter element, minimize touching the filter.  
Touching the filter element may affect the operation of the filter and shorten the service life.

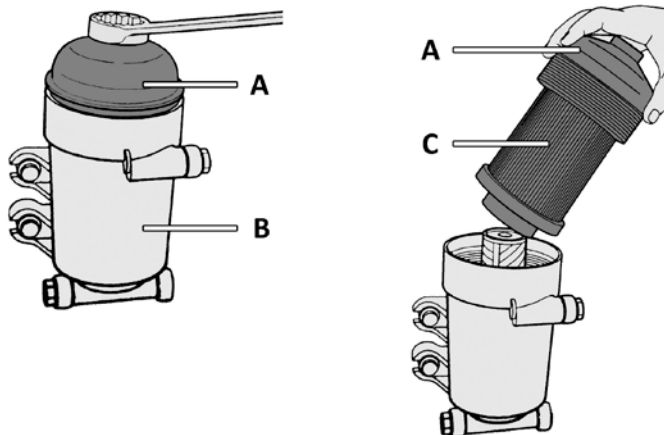

Picture 10-17

1. Remove the central cover plate of the engine cowling;
2. Remove the *filter cover A* (Picture 10-17) from the *filter casing B*;
3. Let the filter casing leak off;
4. Remove the filter cover together with the *filter element C* from the filter casing;
5. Take the filter element out of the filter cover;
6. Clean the filter cover;
7. Replace the O-ring of the filter cover and lightly grease the new O-ring;
8. Mount the new filter element in the filter cover (see § 14.1. *Maintenance specifications*);
9. Mount the filter cover with the filter element over the centre pipe and tighten it on the filter casing by hand;
10. Mount the filter cover with the tightening torque as mentioned on the filter cover;
11. Vent the fuel system (see § 10.4.5. *Venting fuel system diesel engine truck*);
12. Start the engine and let it run for a few minutes;
13. Check the fuel system for leakage;
14. Mount the central cover plate to the engine cowling;
15. Fold the crane.

#### 10.4.5. Venting fuel system diesel engine truck



**CAUTION!**

At all times avoid running the fuel tank dry to prevent damage to the engine!

The procedure described below is an EMERGENCY MEASURE. The engine will start only after long-term pumping. The hand pump is situated on the left side of the engine (*Picture 10-18*).

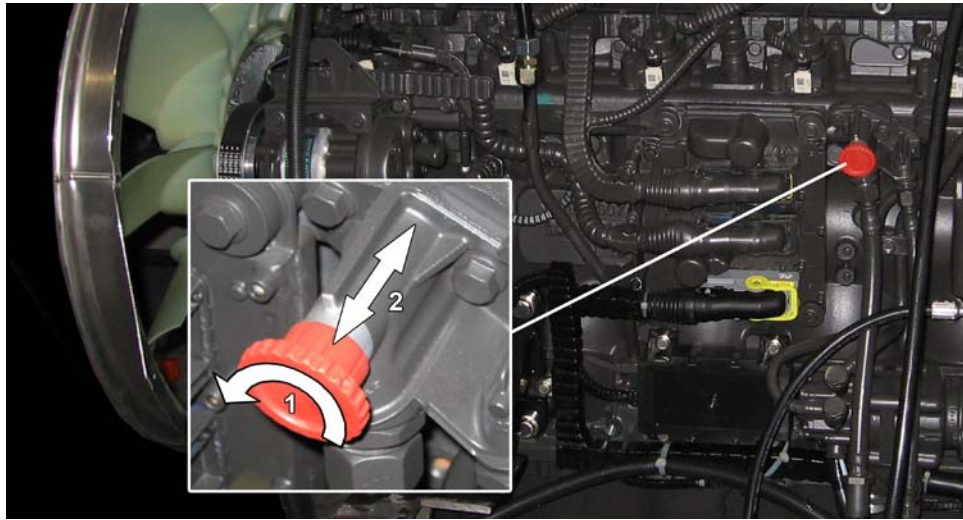

*Picture 10-18*

Venting of the fuel system must be carried out as mentioned below:

1. Operate the hand pump by turning the knob counterclockwise and after that moving the knob in and out (*Picture 10-18*). Operate the hand pump till the resistance of the pump increases noticeable;
2. Tighten the knob of the hand pump by pressing the knob and turning it clockwise;
3. Try to start the engine;
4. After starting, the engine may run irregularly for some time.



**INFORMATION!**

If the engine will not start, please contact your DAF-dealer or Spierings Mobile Cranes.

#### 10.4.6. Fuel transfer pump

The crane is driven by the diesel engine of the crane, which is supplied by the fuel tank of the truck. The fuel is transported by means of *fuel transfer pump* through the slewing ring, to the little fuel tank of the superstructure diesel engine.

This process is fully automatic. If the fuel in the little tank drops down the minimum level, the little tank will be refilled automatically to its maximum level.

The *fuel transfer pump* is situated in the slewing ring on the truck (see *Picture 10-19*, top view via the slewing ring).



Picture 10-19

Via the bottom of the vehicle, the fuel transfer pump is reachable (see *Picture 10-20*, bottom view).



Picture 10-20



## 10.5. EAS system

The DAF engine is equipped with the EAS system (Exhaust Aftertreatment System).

This control system keeps the emission values within the legal requirements, which have been made to this engine.

The EAS system mixes a liquid (so-called AdBlue liquid) with exhaust gases in the exhaust system.

The injection is done electro-pneumatically and takes place just before the damper (catalytic converter). The quantity AdBlue that is sprayed in the damper, is depending on the engine load and is determined by the EAS system.

### INFORMATION!



**After turning off the engine the EAS system goes to overrun. This is possible audible in the vicinity of the AdBlue tank (bubbling sound). Wait with working on the system till the overrun is completed.**

### 10.5.1. AdBlue filter

The AdBlue filter is situated in the EAS unit (*Picture 10-21*) and can be reached from the bottom side.

The EAS unit is situated behind the left front wheel.



*Picture 10-21*

### Replacing AdBlue filter



#### CHECK / TEST!

Timely replace the AdBlue filter to prevent damage to the EAS system.  
For more information, see § 5.2.1. *Maintenance schedule diesel engine truck.*

Replacing the AdBlue filter must be carried out as mentioned below (*Picture 10-22*).

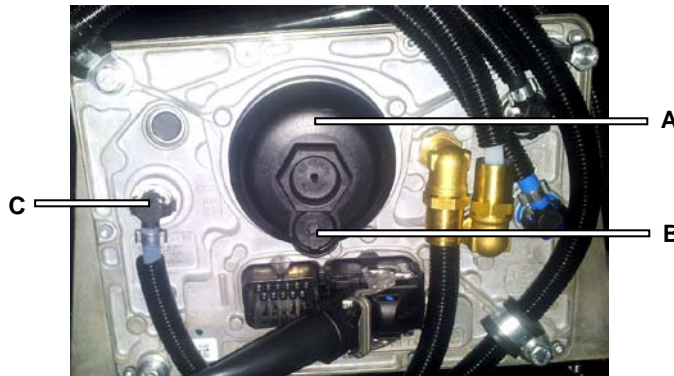

*Picture 10-22*

1. Put a tray under the drainage plug;
2. Remove the *drainage plug B* (*Picture 10-22*) and let the filter casing leak off;
3. Remove the *filter cover A* together with the filter element and the spacers;
4. Replace the sealing ring of the filter cover and lightly grease the new sealing ring;
5. Replace the O-ring of the drainage plug and lightly grease the new O-ring;
6. Mount the new filter element with the new spacers in the filter cover;
7. Mount the filter cover on the filter casing and tighten it with a tightening torque of 25 Nm ( $\pm 5$  Nm);
8. Tighten the drainage plug with a tightening torque of 4 Nm ( $\pm 1$  Nm);
9. Remove *connection C*, replace the gauze and remount *connection C* again.

### 10.5.2. Air filter / oil separator EAS-system

The air filter / oil separator of the EAS-system is situated behind the left front wheel (*Picture 10-23*).



*Picture 10-23*

### Replacing air filter / oil separator EAS system



#### CONDITIONS

There must be no pressure on circuit 4 (10 litres tank) of the pneumatic system.

Replacing the air filter / oil separator (*Picture 10-24*) must be carried out as described below.

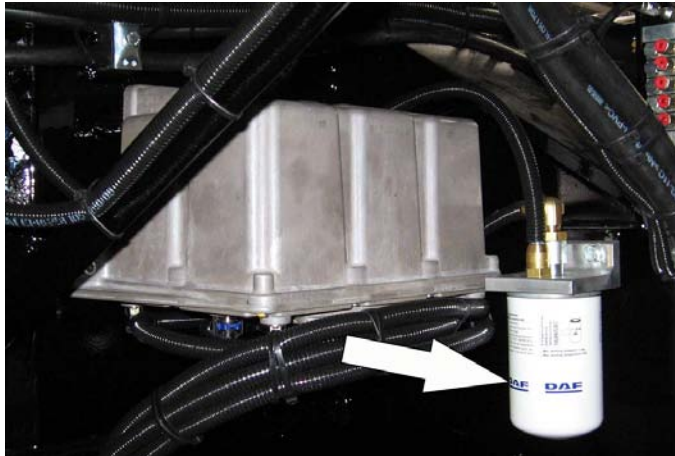

*Picture 10-24*

1. Remove the air filter / oil separator by turning it counterclockwise;
2. Replace the sealing ring and lightly grease the new sealing ring;
3. Turn on the new air filter / oil separator to the filter casing;
4. Tighten the air filter / oil separator by hand for approx.  $\frac{3}{4}$  turn ( $270^\circ$ );
5. Pressurize circuit 4 of the pneumatic system;
6. Check the air filter / oil separator for air leakage.

## 10.6. Drive belts diesel engine truck

#### CHECK / TEST!



Check and replace timely the poly-V-belts to prevent damage to the engine.

For more information, see § 5.2.1. *Maintenance schedule diesel engine truck.*

### 10.6.1. Poly-V-belt



#### CAUTION!

Always mount a new poly-V-belt of the same type  
(see § 14.1. *Maintenance specifications*).

The water pump and the fan for forced cooling are driven by the poly-V-belt.

### Replacing the poly-V-belt

#### INFORMATION!



For replacing the poly-V-belt, the fan at the front of the engine block must be removed.  
Before doing this, remove the *cover plate cab* of the engine cowling (see § 2.4. *Engine cowling*).



#### CONDITIONS

The main switch of the truck must be turned off.

### Removing the fan

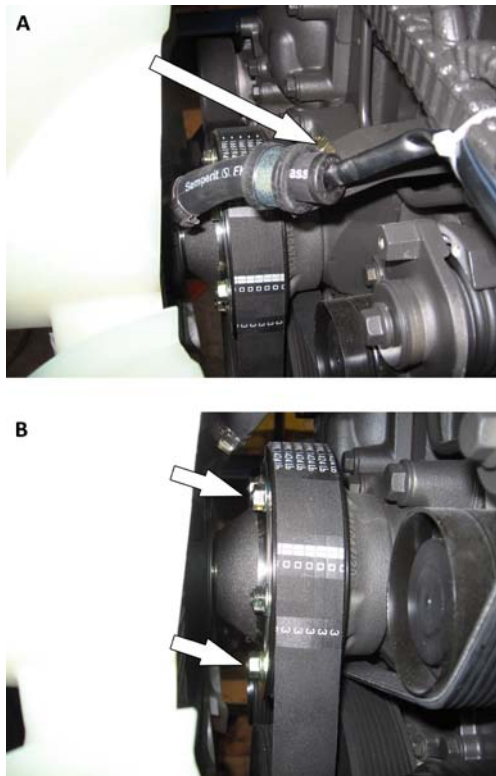

Picture 10-25

1. Unscrew the cable retention of the visco-coupling, so the cable can move freely (Picture 10-25, A);
2. Unscrew the mounting screws of the visco-coupling on the side of the belt pulley (B);
3. Tilt the fan in such a way, that there is enough space for replacing a new belt:
  - Prevent damage to the radiator while tilting the fan.

#### CAUTION!



Always mount a new poly-V-belt of the same type (see § 14.1. *Maintenance specifications*).

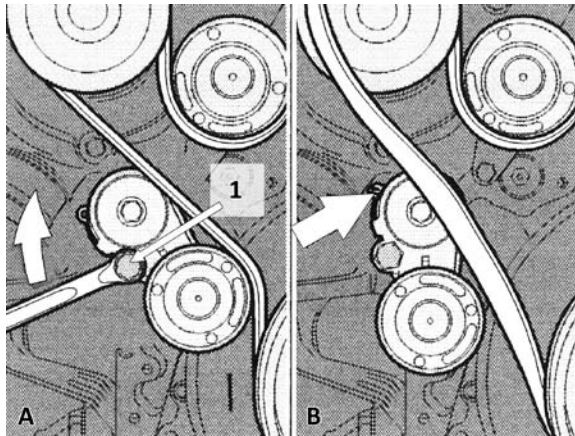

Picture 10-26

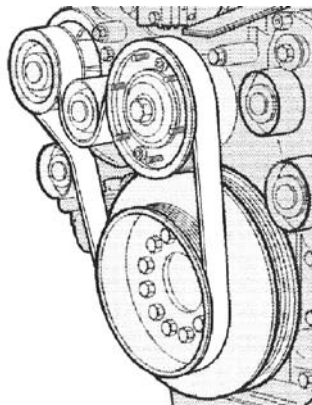

Picture 10-27

1. Loosen the automatic belt tensioner (*Picture 10-26, A, 1*):
  - It is possible to block the belt tensioner temporarily with a 4 - 5 mm pin or drill (*B*);
2. Relax the poly-V-belt, so it can be removed from the pulleys;
3. If the tensioner is not temporarily blocked, then let the automatic belt tensioner slowly cushion to the stop;
4. Remove the poly-V-belt;
5. Check the pulleys for damages, rust and grease deposits;
6. Put the poly-V-belt over as much pulleys as possible;
7. Tension the automatic belt tensioner (if not temporarily blocked) and put the poly-V-belt over the last pulleys;
8. Let the automatic belt tensioner slowly cushion to the new poly-V-belt;
9. Remove the blocking pin, if applicable:
  - By moving the tensioner against the spring force, the blocking pin can be removed;
10. Check if the poly-V-belt is placed in all grooves of all pulleys (*Picture 10-27*);
11. Mount the fan with visco-coupling and tighten it firmly:
  - Use a thread sealing or thread locking (Loctite).

### 10.6.2. Poly-V-belt of the alternator

The alternator and the air condition pump are driven by the poly-V-belt of the alternator.

#### Replacing the poly-V-belt of the alternator



##### CONDITIONS

The main switch of the truck must be turned off.



##### CAUTION!

Always mount a new poly-V-belt of the same type  
(see § 14.1. Maintenance specifications).

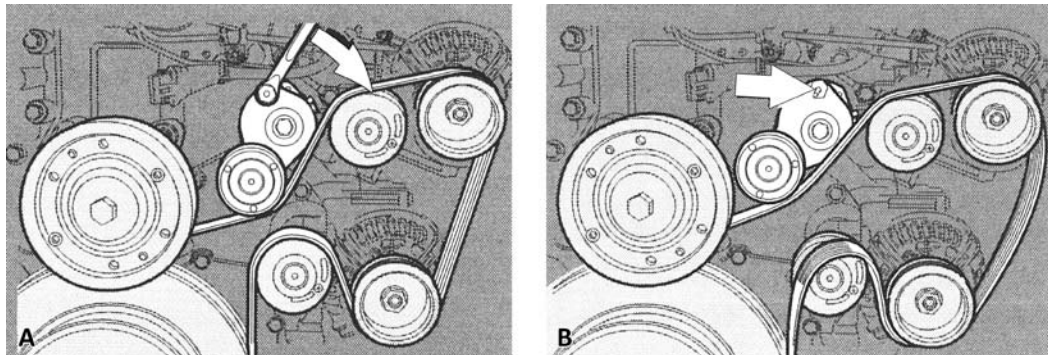

Picture 10-28

1. Remove the poly-V-belt (see § 10.6.1. Poly-V-belt);
2. Loosen the automatic belt tensioner:
  - It is possible to block the belt tensioner temporarily with a 4 - 5 mm pin or drill (Picture 10-28, B);
3. Relax the poly-V-belt of the alternator, so it can be removed from the pulleys;
4. If the tensioner is not temporarily blocked, then let the automatic belt tensioner slowly cushion to the stop;
5. Remove the poly-V-belt of the alternator;
6. Check the pulleys for damages, rust and grease deposits;
7. Put the poly-V-belt of the alternator over as much pulleys as possible;
8. Tension the automatic belt tensioner (if not temporarily blocked) and put the poly-V-belt of the alternator over the last pulleys;
9. Let the automatic belt tensioner slowly cushion to the new poly-V-belt of the alternator;
10. Remove the blocking pin, if applicable:
  - By moving the tensioner against the spring force, the blocking pin can be removed;
11. Check if the poly-V-belt of the alternator is placed in all grooves of all pulleys;
12. Mount the fan with visco-coupling and tighten it firmly:
  - Use a thread sealing or thread locking (Loctite).

## 11. Drive line

### 11.1. Gear box

Picture 11-1 shows an overview of the drive line.

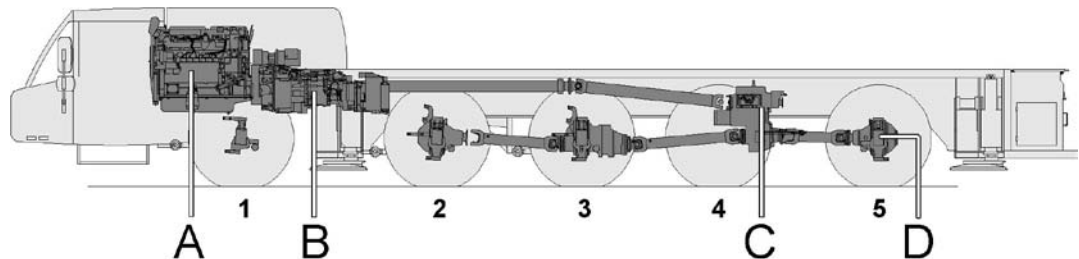

Picture 11-1

- A. Diesel engine;
- B. Gear box;
- C. Transfer case;
- D. Axles (axles 2, 3 and 5 are driven).

#### 11.1.1. Specifications gear box

The automatic gear box with integrated retarder has 16 forward gears and 2 reverse gears, which are electro-pneumatically switched. Because of this, a dry clutch will do. The retarder is a transmission brake, which generates braking force without using the service brake.

### 11.2. General maintenance gear box

#### CAUTION!



When cleaning with pressurised water, make sure that no water can enter the air vent. This may lead to serious damage to the gear box.

#### CHECK / TEST!



Check the gear box every 2 months for external leakage and check if the air vent is free of dirt, so the operation remains guaranteed.

### 11.2.1. Checking oil level gear box

**CAUTION!**



In order to avoid measurement errors, the oil level may not be checked immediately after operating. The oil temperature must be below 40 °C.



**CHECK / TEST!**

Check the oil of the gear box every 2 months at normal operating conditions.

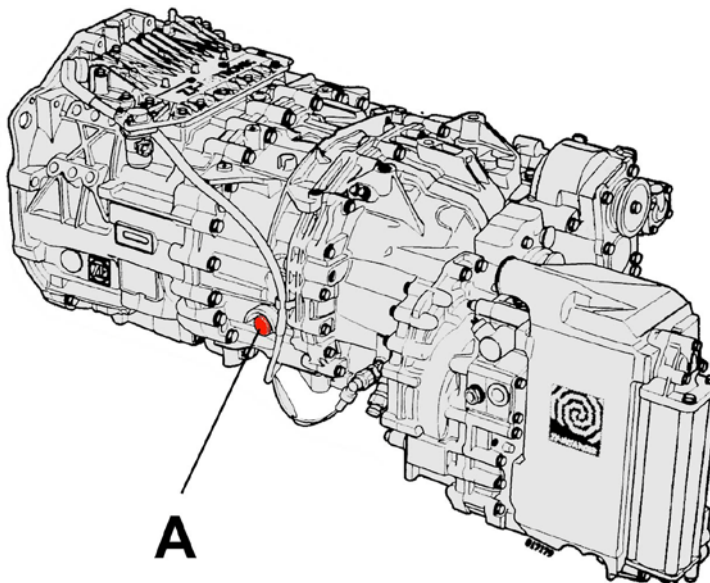

Picture 11-2

1. Make sure that the vehicle stands on a flat horizontal surface;
2. Remove the filler plug (see *Picture 11-2, A*);
3. If the oil level is not immediately below the filler neck, then refill (see § 14.2.1. *Specifications gear box*);
4. Mount the filler plug with a tightening torque of 60 Nm.



### 11.2.2. Refreshing oil gear box

**CAUTION!**



The gear box and the oil are very hot if the truck is driven for quite some time. Refresh the oil every 30,000 km or at least once a year.



Picture 11-3

1. Make sure that the vehicle stands on a flat horizontal surface;
2. Put an oil tray under the drainage plugs (*Picture 11-3, B and C*);
3. Remove the drainage plugs;
4. Remove the filler plug (see *Picture 11-2, A*);
5. Let the oil drain;
6. Clean the drainage plugs and refresh the sealing rings. The drainage plugs (*Picture 11-3, B and C*) are magnetic, so parts of metal are collected there;
7. Mount the drainage plugs (*B and C*) with a tightening torque of 60 Nm;
8. Top up new oil via the filler neck (*Picture 11-2, A*), till the bottom of the filler neck is reached (see § 14.2.1. *Specifications gear box*);
9. Mount the filler plug with a tightening torque of 60 Nm;
10. After topping up, let the gear box run for testing (protract the outriggers, block the differentials), causing the retarder to be activated;
11. After that, check the oil level and top up, if necessary (see § 11.2.1. *Checking oil level gear box*).

### 11.2.3. Replacing oil filter retarder

Always replace the oil filter (see § 14.2.1. *Specifications gear box*), which is situated at the back of the gear box (*Picture 11-4, A*), directly after the oil drainage.

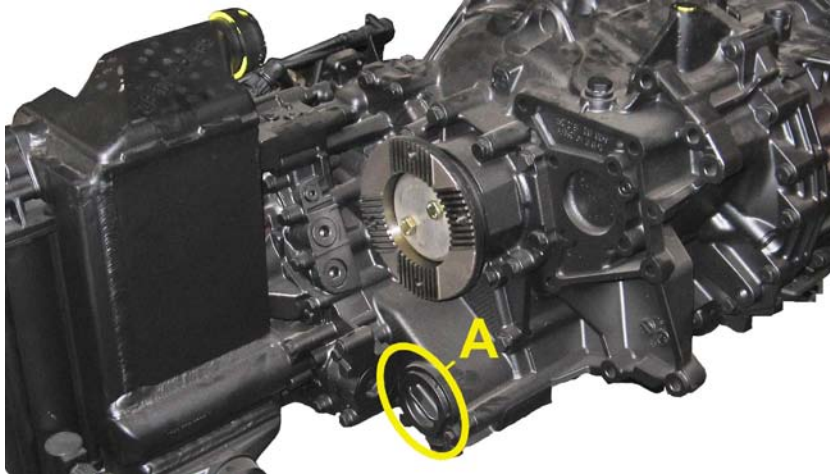

Picture 11-4

#### CAUTION!



In order to avoid measurement errors, the oil level may not be checked immediately after operating. The oil temperature must be below 40 °C.

#### CHECK / TEST!



Refresh the oil filter every year or every 30,000 km at normal operating conditions. For more information, see § 5.2.1. *Maintenance schedule diesel engine truck.*

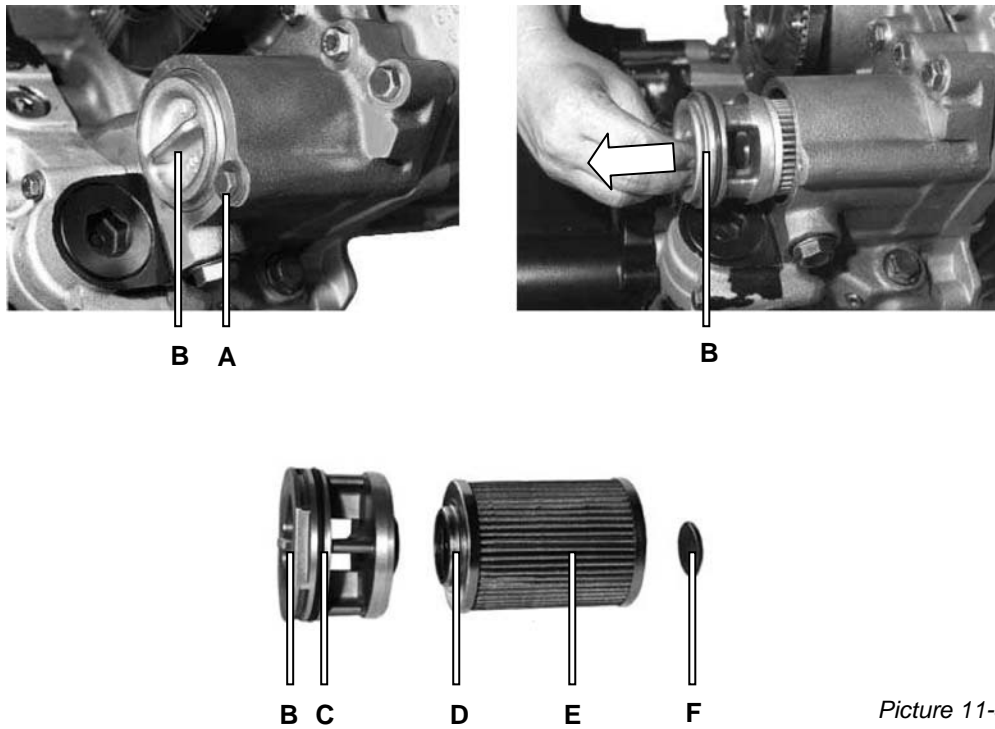

Picture 11-5

1. Unscrew *bolt A* (Picture 11-5);
2. Pull the *cover B* including the *filter element E* out of the filter casing;
3. Remove *magnet F* at the back of the filter element and clean it;
4. Remove the old filter element of the cover;
5. Check the *cover B* for damages;
6. Replace the *O-ring C*:
  - **Please note that the O-ring must be ordered separately!**
7. Lightly grease both the O-ring of the *cover D* and the new filter element;
8. Mount the new filter element in the cover;
9. Mount the magnet at the back of the new filter element;
10. Insert this part in the filter casing;
11. Tighten the cover with the bolt.

### 11.3. Transfer case

The transfer case is a ZF type VG2001/396. This transfer case (*Picture 11-6*) distributes the power at the *input shaft 1* over two *output shafts 2 and 3* and *internal output shaft A*.

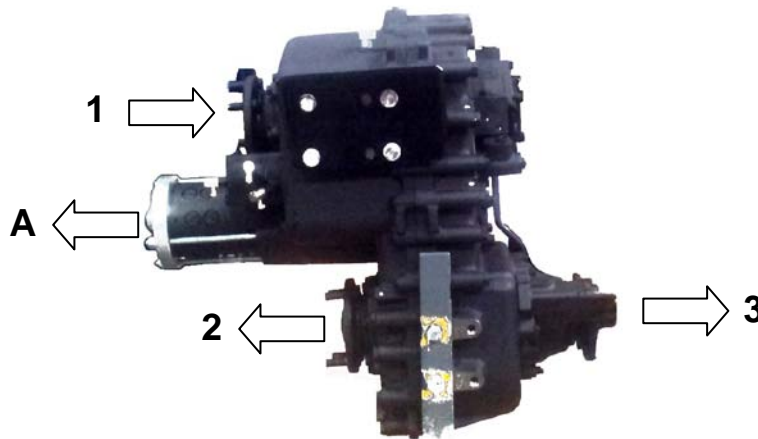

*Picture 11-6*

- Drive axles 2 and 3 are driven by *output shaft 2*;
- Drive axle 5 is driven by *output shaft 3*.

The transfer case has two gear ratios:

- High: 1 : 0.89 (on the road);
- Low: 1 : 1.536 (off the road).

The *internal output shaft A* drives the emergency steering pump (hydraulic pump), which is used if the engine fails. This pump only works when the vehicle is moving.

#### 11.3.1. General maintenance transfer case

##### CAUTION!



When cleaning with pressurised water, make sure that no water can enter the air vent. This may lead to serious damage to the transfer case.

##### CHECK / TEST!



Check the transfer case every 2 months for external leakage and check if the air vent is free of dirt, so the operation remains guaranteed.

### 11.3.2. Checking oil level transfer case

#### CAUTION!



In order to avoid measurement errors, the oil level may not be checked immediately after operating. Measuring with a cold motor is also not correct. It is better to drive the vehicle for a moment (if the engine is cold) before measuring the oil level. In this way the oil is spread around the entire transfer case. The oil temperature must be below 40 °C.

#### CHECK / TEST!



Check the oil level of the transfer case every 2 months at normal operating conditions. The oil temperature must be below 40 °C.

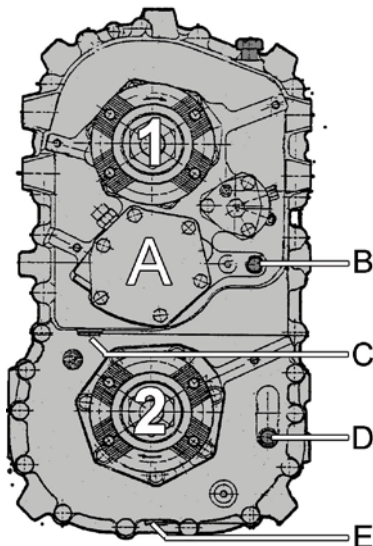

Picture 11-7

Shaft 1 (Picture 11-7) is the input shaft and shaft 2 (Picture 11-7) is the output shaft for driving axles 2 and 3.

1. Make sure that the vehicle stands on a flat horizontal surface;
2. Remove the *plugs B* and *D* from the filler necks;
3. The oil level must just be under the *filler neck D*:
  - If this is not the case, top up oil (§ 11.3.3. Refreshing oil transfer case) by using *filler neck B* till the oil leaves *filler neck D*;
4. Let the oil drain;
5. Mount the *plugs B* and *D*.

### 11.3.3. Refreshing oil transfer case



**CAUTION!**

The transfer case and the oil are very hot if the truck is driven for quite some time.



**CHECK / TEST!**

Refresh the oil once per 2 years at normal operating conditions.  
For more information, see § 5.2.2 *Maintenance schedule drive line*.

1. Make sure that the vehicle stands on a flat horizontal surface;
2. Put an oil tray under the *drainage plugs C and E* (Picture 11-7);
3. Remove the *drainage plugs C and E* and collect the oil;
4. Clean the drainage plugs and replace the sealing rings;
5. Mount the drainage plugs;
6. Remove *filler plugs B and D*;
7. Top up via *filler neck B* approx. 6,5 litres till the edge of *filler neck D* is reached (see § 14.1. *Maintenance specifications* and § 14.2.2. *Specifications transfer case*);
8. Mount *filler plugs B and D*.

### 11.4. Axles

All axles are from the manufacturer Kessler & Co.

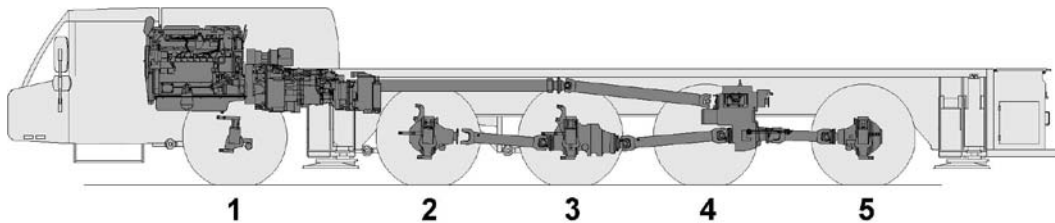

Picture 11-8



**CAUTION!**

When cleaning with pressurised water, make sure that no water can enter the air vent. This may lead to serious damage to the gear box.

### 11.4.1. Axle configuration

The axle configuration is shown in *Table 11-1*.

Axle	Steered	Driven		Differential	End delay
1	Yes	No	--	--	--
2	Yes	Yes	Mechanically	End	7.29
3	No	Yes	Mechanically	Throughput	7.29
4	Yes	No	--	--	--
5	Yes	Yes	Mechanically	End	7.29

*Table 11-1*

### 11.4.2. Checking oil level differentials

**CAUTION!**



In order to avoid measurement errors, the oil level may not be checked immediately after operating. The oil temperature must be below 40 °C.

**CHECK / TEST!**



Check the oil level of the differentials every 2 months at normal operating conditions. Also check if the air vents of the differentials are free from dirt, so the operation remains guaranteed.

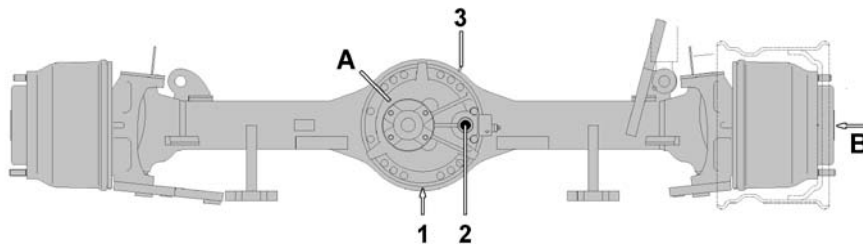

*Version axle with end differential*

*Picture 11-9*

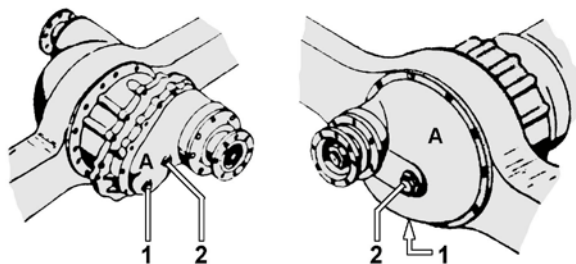

*Version axle with throughput differential*

*Picture 11-10*

1. Make sure that the vehicle stands on a flat horizontal surface;
2. Unscrew *filler plug 2* out of the filler neck of *differential A* (*Picture 11-9* and *Picture 11-10*);
3. Check if the oil reaches *filler neck 2*:
  - If this is not the case, top up by means of the filler neck  
(see § 14.1. *Maintenance specifications* and § 14.2.3. *Specifications axles / brakes / tyres*);
4. Mount *plug 2*.

#### 11.4.3. Refresh oil differential



**CAUTION!**

The differentials and the oil are very hot if the truck is driven for quite some time.



**CHECK / TEST!**

Refresh the oil once per 4 years at normal operating conditions.  
For more information, see § 5.2.2 *Maintenance schedule drive line*.

1. Make sure that the vehicle stands on a flat horizontal surface;
2. Put an oil tray under the *drainage plug*;
3. Remove the *drainage plug 1* (*Picture 11-9* and *Picture 11-10*) and collect the oil;
4. Clean the drainage plug;
5. Replace the sealing ring;
6. Mount the drainage plug;
7. Remove *filler plug 2* from the filler neck;
8. Top up the differentials via the filler neck till the edge and let it drain  
(see § 14.2.3. *Specifications axles / brakes / tyres*);
9. Mount the plug;
10. Check if the *air vent 3* (*Picture 11-9*) is free from dirt.



#### 11.4.4. Checking oil level axle hubs



**CHECK / TEST!**

Check the oil level of the axle hubs every 2 months at normal operating conditions.

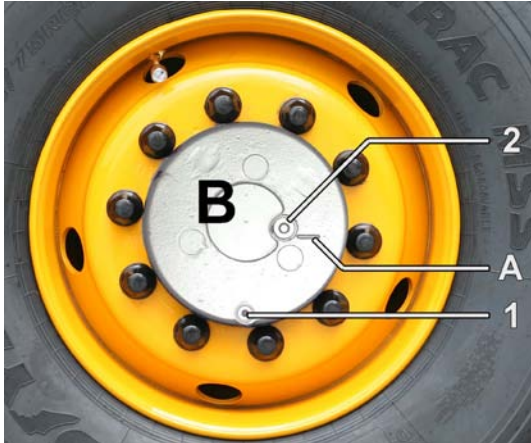

Picture 11-11

The axle hubs *B* (Picture 11-11) of the driven axles are filled with oil.

1. Make sure that the vehicle stands on a flat horizontal surface;
2. Before checking, make sure that *level mark A* is in a horizontal position and the *drainage plug 1* is at the bottom of the circle;
3. Remove *plug 2* out of the filler neck and replace the sealing ring;
4. Check if the oil level reaches the filler neck;
  - If necessary, refill oil via *filler neck 2* (see § 14.2.3. *Specifications axles / brakes / tyres*);
5. Mount the plug;
6. Carry out the above mentioned steps for all axle hubs on the driven axles (see *Table 11-1*).

#### 11.4.5. Refreshing oil axle hubs



**CAUTION!**

The axle hubs and the oil are very hot if the truck is driven for quite some time.



**CHECK / TEST!**

Refresh the oil once per 2 years at normal operating conditions.  
For more information, see § 5.2.2. *Maintenance schedule drive line.*

1. Make sure that the vehicle stands on a flat horizontal surface;
2. Before checking, make sure that *level mark A* is in a horizontal position and the *drainage plug 1* is at the bottom of the circle;
3. Put an oil tray under the drainage plug;
4. Remove *drainage plug 1* and *plug 2* from the filler neck;
5. Clean the drainage plug;
6. Put a new sealing ring on the filler plug;
7. Mount the drainage plug;
8. Top up the drive axles via the filler neck till the oil reaches the edge and let it leak off (see § 14.2.3. *Specifications axles / brakes / tyres*);
9. Mount *plug 2*.

## 11.5. Tyres

### 11.5.1. General maintenance

#### CHECK / TEST!

Check the tyre pressure daily (cold tyres) at normal operating conditions;



Check the tyres (and rims) daily for wear and damage such as tears, bulges or sidewall damage.

#### CHECK / TEST!



- Daily check the valves for dirt. Clean if necessary;
- Daily check the valves for air leakage;
- Daily check the presence of valve caps. If absent, mount new caps to prevent air leakage.

To ensure the safety on the road, the tyres and rims need to be checked daily for pressure (see § 11.5.2. *Tyre pressure*), wear and damage such as tears, bulges or sidewall damage.

This should be done for both the outside and the inside of the wheels.

Turn the steering wheel completely to the left or right to obtain a better view.

In case of doubt, please contact Spierings Mobile Cranes.

Spierings Mobile Cranes recommends to write down the tyre pressure for each tyre at every check to monitor the progress of the tyre pressure in a certain period of time.

If the same tyre loses pressure every time, then this is an important signal in order to preventively replace this tyre.

After a long drive in which a lot of “fast speed” is driven or a lot is braked, the crane should be driven at a lower speed for some time. This allows the wind to gradually dissipate the accumulated heat in the brake drums.

The cranes will be delivered with one of the following tyre brands: Goodyear, Michelin or Windpower. For more information from the manufacturer, see *Annex 5*.

### 11.5.2. Tyre pressure



Picture 11-12

1. Check the tyre pressure of all tyres to be 9.0 up to 9.2 bar (cold tyres)  
(reading *Annex 5* for information of the supplier is strongly recommended):

- Use the supplied air pressure gauge (*Picture 11-12*);
  - Inflate the tyres to the indicated pressure range, if necessary;
2. Use compressed air to bring the tyre at the proper pressure (9.0 to 9.2 bar);
  3. Mount the valve cap with the correct sealing ring on the valve.

**CAUTION!**



**It is harmful for the tyres to have a tyre pressure below 9.0 bar!  
Check the tyre pressure daily.**

## 11.6. Brake linings

### 11.6.1. Checking brake linings

**CHECK / TEST!**



**Check the brake linings during maintenance or at least once a year at normal operating conditions.**

At the rear of every brake drum, it can be checked if the brake linings are still thick enough to drive safely on the road (*Picture 11-13, A*).

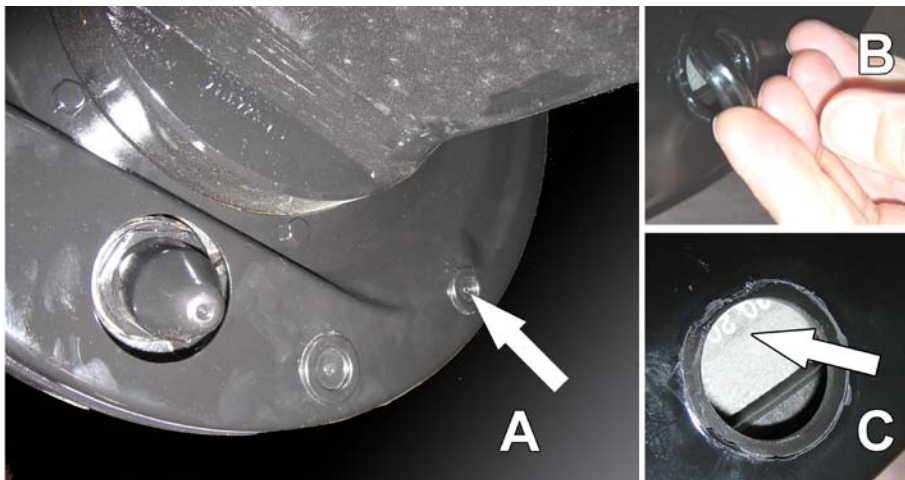

*Picture 11-13*

1. Remove the rubber sealing ring out of *hole B* (*Picture 11-13*);
2. Check the thickness of the *brake lining C*;
3. Mount the rubber sealing.

Replace the brake lining (see § 14.2.3. *Specifications axles / brakes / tyres*), if it is worn to the wear ring, which is indicated on the brake lining.

It is recommended to have the brakes tested on a brake analyser every year.

## 12. Steering system

Picture 12-1 shows how the steering system is built.

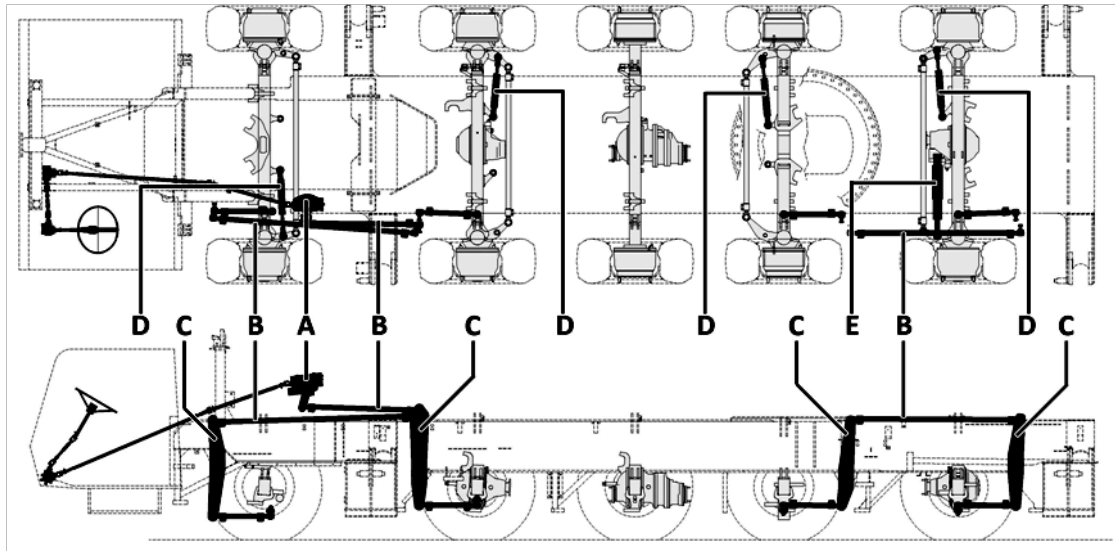

Picture 12-1

- A. Steering box;
- B. Steering rod;
- C. Steering arms;
- D. Auxiliary steering cylinders;
- E. Main steering cylinder rear axle.

The rotary movement of the steering wheel is activated in the *steering box A* and transposed into the mechanical movement of the *steering rod B*, which operates the *steering arms C* of the axles.

On the axles, there are *auxiliary steering cylinders D* mounted for power-assisted steering.

Axles 4 and 5 are not mechanically connected to axles 1 and 2, but they are hydraulically steered by means of a valve block and a *main steering cylinder E*.

### 12.1. Steering modes

The steering system of the truck has two steering modes (see § 4.13. *Off-the-road driving*):

- On-the-road mode;
- Off-the-road mode.



Use 32. *Switch steering system on-the-road / off-the-road* on the control panel to switch the steering system between *on-the-road mode* (steering wheel) and *off-the-road mode* (hand).

This may only be carried out when the vehicle is not moving.

### 12.1.1. On-the-road mode

In the on-the-road mode the front axles 1 and 2 are mechanically steered, while axles 4 and 5 are steering in the opposite direction (up to 50 kph (31 mph)). This causes a smaller turning circle.

### 12.1.2. Off-the-road mode

The off-the-road mode provides the possibility for using 4 different steering programs. A steering program can be chosen by means of the *control panel steering system* (see § 3.9.5. *Control panel steering system*).

The steering programs distinguish from each other by the difference in steering characteristics of the rear axle:

**1. Small turning circle:**

In this steering program an extra small turning circle is possible;

**2. Manual:**

In this steering program the position of the rear axle(s) is manually adjusted;

**3. Crab steering:**

In this steering program all axles are steered in the same direction;

**4. Wall steering:**

In this steering program it is possible to drive away from an obstacle with a minimum swing of the rear of the truck.

In the off-the-road mode, the vehicle speed is limited to 15 kph (9.4 mph).

In § 4.13.5. *Manoeuvring: Steering system* the steering programs are extensively described.

## 12.2. Steering mechanisms

In this section the used steering mechanism per axle is described (see *Table 12-1*).

A distinction is made in the following mechanisms:

- **Mechanical:**

The rotating movement of the steering wheel is activated in the steering box and transposed into the mechanical movement of the steering rods. These rods operate the steering arms of the axles 1, 2 and 3;

- **Hydraulic:**

Axles 4 and 5 are hydraulically steered by means of a valve block and a main steering cylinder;

- **Retracted axle:**

After choosing a steering program, this axle is placed in the height position. If the axle is fully retracted, a buzzer will shortly sound.

- **Non-steering axle:**

Concerns a non-steering axle.

Axle	On-the-road mode (0 - 83 kph) (0 - 52 mph)	Off-the-road mode (< 15 kph (9.4 mph))			
		Small turning circle	Manual	Crab steering	Wall steering
Axle 1	Mechanical				
Axle 2	Mechanical				
Axle 3	Non-steering axle	Retracted axle			
Axle 4	Electronical – hydraulic				
Axle 5	Electronical – hydraulic				

Table 12-1

### 12.3. Performance steering system

On the mechanically steered steering axle 1 and the hydraulically steered rear axles 4 and 5, steering angle sensors are mounted, which measure the current steering angle.

The measuring signals are processed by the Electronic Control Unit (ECU) of the steering system.

The ECU then controls the position of the hydraulically steered axles by means of the chosen steering mode or the chosen steering program, by steering the hydraulic valve block.

In *Picture 12-2* the operation of the steering system is schematically shown.

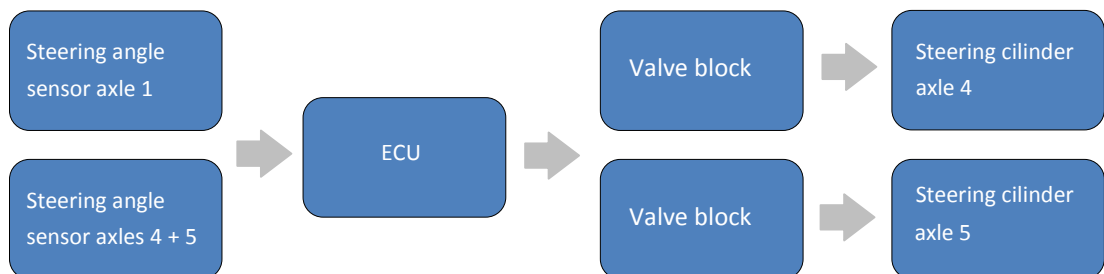

Picture 12-2

### 12.3.1. Steering circuits

**CAUTION!**

 In case a failure in the steering system occurs, **ALWAYS** contact Spierings Mobile Cranes. Stop as soon as possible to restore the failure!

#### 12.3.1.1. Steering circuit 1

**CAUTION!**

 If the air pressure of steering circuit 1 is eliminated, the vehicle remains steerable until it comes to a standstill.  
The vehicle steers considerably heavier by the loss of the power-assisted steering. Stop as soon as possible to restore the failure.

The steering pump on the diesel engine provides *steering circuit 1* with pressure for activating the steering box and the steering cylinders on the front steering axles.

The hydraulic pump on the flywheel housing of the diesel engine provides a.o. *steering circuit 1* with pressure for activating the steering box and the steering cylinders on the front steering axles.



If the pressure of *steering circuit 1* is lost, symbol *No pressure steering circuit 1* appears on the *main screen*. The *yellow warning light* also becomes active.

#### 12.3.1.2. Steering circuit 2

The emergency steering pump on the transfer case provides *steering circuit 2* with oil for activating the steering box, if the pump on the diesel engine of the truck fails. This circuit is independent of the diesel engine and ensures in case of an emergency that the vehicle remains steerable till it comes to a stop.



When *steering pump 2* becomes active, the steering box disables the activating of the steering cylinders on the front steering axles. Symbol *Power-assisted steering front steering axles not active* appears on the main screen. The *yellow warning light* also becomes active.



If the pressure of *steering pump 2* is lost, symbol *No pressure steering circuit 2* appears on the main screen. The *yellow warning light* also becomes active.

The message is active by default if the vehicle stands still (< 5 up to 8 kph (< 3.1 up to 5 mph)), because of the emergency steering pump not building pressure.



### 12.3.1.3. Rear axle steering

#### CAUTION!



If an electrical malfunction occurs, the vehicle remains steerable.  
Only the mechanically steered axles can be steered, increasing the turning circle significantly.



If the steering system fails, symbol *Malfunction steering system* appears on the main screen.

In some cases, the *yellow warning light* becomes active. The error code(s) appear(s) on the display of the *control panel steering system* on the control panel.

Please write down this error code(s) and contact Spierings Mobile Cranes.

If an electrical malfunction occurs while driving the vehicle, it remains steerable.

The steering system ensures that the main steering cylinder of the rear axle will centre and rigid itself.

The mechanically steered axles remain normally steerable.

Stop as soon as possible to restore the failure.

For more information, see *Chapter 8. Hydraulic system*.

## 12.4. Maintenance steering system

### 12.4.1. Checking steering system

#### CHECK / TEST!



Check every 2 months if there is no play in the steering arms, steering ball joints, steering box(bolts) and steering rods of the steering system.



#### ENTRAPMENT HAZARD!

Make effective arrangements with each other in order to prevent entrapment!

Check the steering system with two people! Secure the crane to its *transport position*.

While one person moves the steering wheel slightly to the left and to the right, the other one must check the steering arms and steering ball joints, steering box (bolts) and steering rods for play and wear.

### 12.4.2. Aligning

#### CHECK / TEST!



To prevent excessive tyre wear, the truck must be aligned once a year.

Before aligning the vehicle, play of the steering arms and steering rods must be checked.

Since the vehicle is equipped with electronic centre position signalling, before aligning it is recommended to contact Spierings Mobile Cranes.



## 13. Lubrication

Lubrication of the Spierings vehicle consists of lubrication points, which can manually be greased and lubrication points, which are provided with grease by the *automatic lubrication system*.

Also see the lubrication diagram, which will be separately supplied.

Lubrication is divided in:

- Automatic lubrication system truck;
- Manual lubrication truck.



### CHECK / TEST!

Timely remove old grease!

### 13.1. Automatic lubrication system truck



### CHECK / TEST!

Timely check the performance of the *automatic lubrication system truck* by checking any lubrication point for the presence of grease.  
Also see § 13.1. *Automatic lubrication system truck*.

#### 13.1.1. Grease pump

The *automatic lubrication system truck* has one *grease pump* (see *Picture 13-1*).

This grease pump is controlled by means of a *timer automatic lubrication system truck*.



Picture 13-1

The grease pump (with reservoir) is situated behind the left-hand engine cowling (see *Picture 13-1*).

For checking and topping up, the left-hand cover must be opened.

The grease in the grease reservoir must be above *minimum level A*.

Use the *lubrication nipple B* for topping up.

Use grease according to the specifications mentioned in § 14.6. *Specifications lubricants truck*.

### 13.1.2. Timer

The lubrication time of the *automatic lubrication system truck* is adjusted by means of the *timer automatic lubrication system truck* in the dashboard at the co-driver's side (*Picture 13-2*).

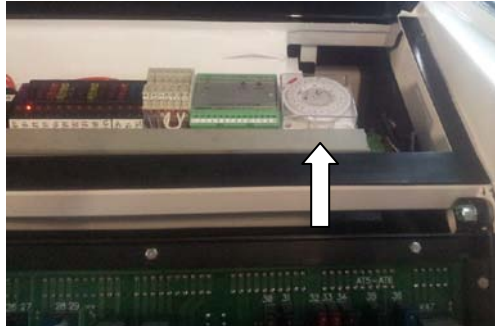

Picture 13-2

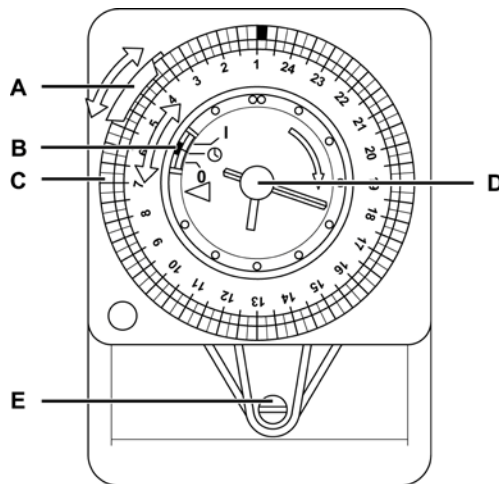

Picture 13-3

- A. Switch 0 / clock / 1:
- 0: Grease pump disabled;
  - Clock: Timer active;
  - 1: Grease pump continuously enabled;
- B. Indicator 0 / clock / 1:
- 0: Grease pump disabled;
  - Clock: Timer active;
  - 1: Grease pump continuously enabled;
- C. Switching segment;
- D. Pointers;
- E. Screw cover.
1. The timer is active when the ignition of the truck is turned on (see *Picture 13-3*):
    - One switching segment upwards is equal to 15 minutes lubricating per 24 hours;
  2. Remove the cover before adjusting the timer:
    - Unscrew counterclockwise for loosening the screw;
  3. Activate the timer by moving switch 0 / clock / 1 to its central position.

### 13.1.3. Lubrication points central lubrication system

The following lubrication points are part of the central lubrication system:

- A. Pins for fixing spring cylinders up and down (see *Picture 13-4*);
- B. Stub axles up and down (see *Picture 13-4*);
- C. Support bearing steering axle (see *Picture 13-5*).

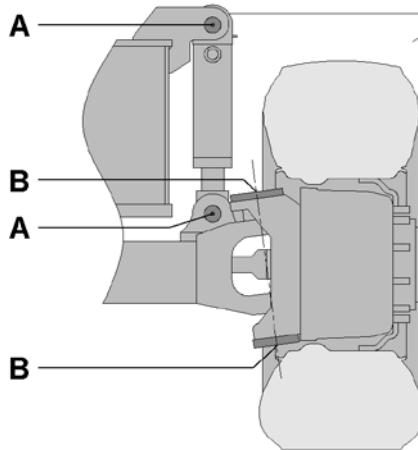

*Picture 13-4*



*Picture 13-5*

## 13.2. Manual lubrication truck

When lubricating manually the grease gun must be used, unless mentioned otherwise.

For more information, see § 14.6. *Specifications lubricants truck.*

For lubrication intervals, see § 5.2.8. *Maintenance schedule lubrication truck.*

### 13.2.1. Retractable cylinders outrigger beams

*Picture 13-6, A* shows the position of the lubrication nipple of the retractable cylinder inside the beam.

For lubricating these nipples, the outrigger beams must be extended till the holes are reachable.

Via these holes the lubrication nipples can be reached (one per each beam).

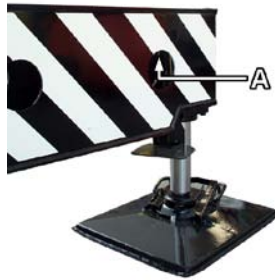

Picture 13-6

### 13.2.2. Drive shafts

The couplings of the drive shafts must be lubricated manually.

There is a lubrication nipple present in the coupling (see *Picture 13-7, A*).

*Picture 13-8 (A to I)* shows the locations of the couplings to be lubricated.

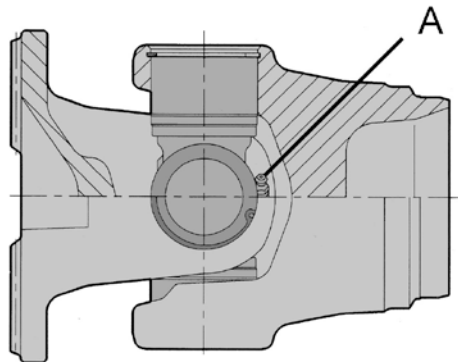

Picture 13-7

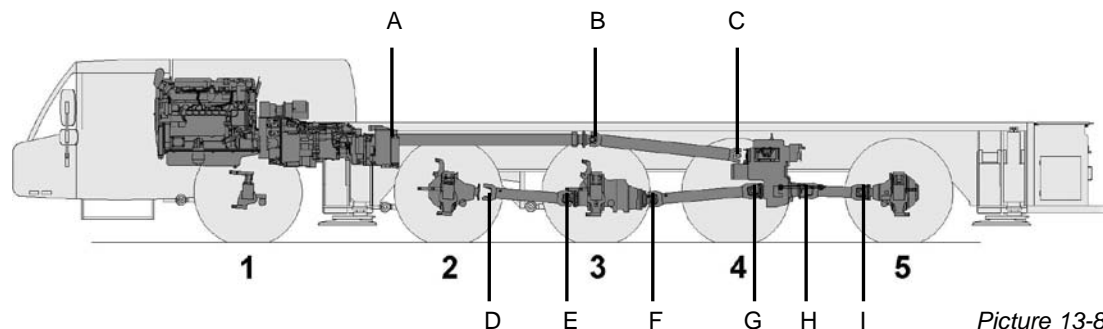

Picture 13-8

### 13.2.3. Steering system

The several ball couplings of the steering rods are free of maintenance, except the splines.

These must be lubricated manually (see *Picture 13-9, A*).

It is recommended to extra lubricate the ball coupling by means of the needle lubricating nipple.

#### CHECK / TEST!



In addition to lubricate the splines, also check if all couplings and connections of the steering system show no play.

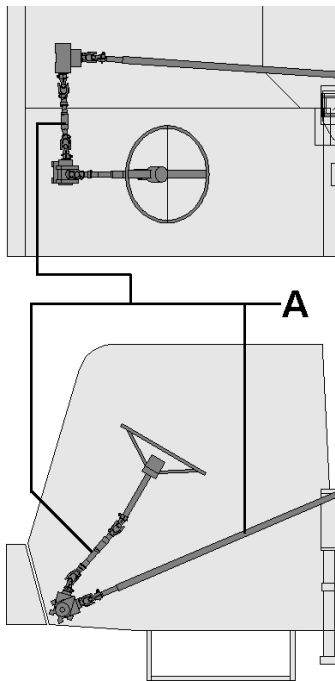

Picture 13-9

### 13.2.4. Tower support

The tower support is situated directly behind the cabin on top of the engine cowling (see *Picture 13-10, A*).

Grease the two guide ways using a brush (see lubrication schedule in the Annex).

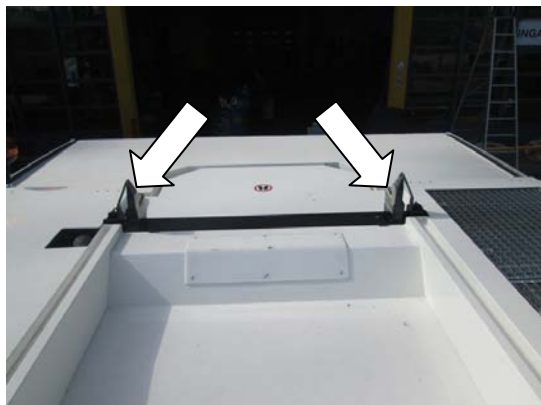

Picture 13-10





## 14. Specifications truck

For the manual of the diesel engine truck, it is referred to the website of the manufacturer.

The specifications of the diesel engine are described in § 10.1. *Specifications diesel engine truck.*

### 14.1. Maintenance specifications diesel engine truck

Description	Specification	Spierings code	Quantity / Amount
Diesel engine Euro5	DAF MX375	AADI00010080	1x
Engine oil	SAE 10W40 ACEA E6	OLSM00100180	Min. 27 litres Max. 36 litres
Oil filter	DAF 1643070	SERV01150110	1x
Coolant	TotalFinaELF Cool plus -37°C	OLSM00100080	9 litres
Air filter	External filter AF25454 Internal filter AF25468	SERV03100170 SERV03100180	1x 1x
Fuel pre-filter / water separator	Racor DAF 1296851	SERV04300010	1x
Fuel filter	Filter element DAF 1699168	SERV1150100	1x
AdBlue filter	Filter element DAF 1789050	SERV05600010	1x
Air filter / oil separator EAS system	EAS air filter DAF 1686587	AADI00600090	1x
Poly-V-belt	DAF 1661949 (9 stripes)	AADI09500070	1x
Poly-V-belt alternator	DAF 1638698 (7 stripes)	AADI09500080	1x

Table 14-1

## 14.2. Specifications drive line

### 14.2.1. Specifications gear box

Description	Specification	Spierings code	Quantity / Amount
Gear box	ZF 16AS2631	AAVE01000070	1x
Oil gear box	SAE 75W80 full synthetic	OLSM00100190	Refresh: 13 litres
Oil filter gear box	ZF 4139 298 038	AAVE00150030	1x
O-ring	ZF 9634 313 067	AAVE00150040	1x

Table 14-2

### 14.2.2. Specifications transfer case

Description	Specification	Spierings code	Quantity / Amount
Oil transfer case	SAE 75W90 full synthetic	OLSM00100120	6 litres
Sealing ring oil drainage plug	Copper sealing ring 22x27x1,5 mm DIN7603	BERI0302015	1x

Table 14-3

### 14.2.3. Specifications axles / brakes / tyres

Description	Specification	Spierings code	Quantity / Amount
Oil differential axle 2	SAE 75W90 full synthetic	OLSM00100120	17 litres
Oil differential axle 3	SAE 75W90 full synthetic	OLSM00100120	20 litres
Oil differential axle 4	SAE 75W90 full synthetic	OLSM00100120	17 litres
Oil axle hubs	SAE 75W90 full synthetic	OLSM00100120	1.3 litres
Brake shoes, axle 1 + 2 (exchange)	Kessler 410x180ZE	AAA20000010R	4x
Brake shoes, other axles (exchange)	Kessler 410x180DE	AAA20000011R	4x
Tyres	Goodyear Omnitrac 445/75 R22.5 170J	AACA01100120	8x
Tyre pressure (cold)	n.a.	n.a.	9.0 – 9.2 bar
Rim	22.5" x 14"	AACA01100030	8x

Table 14-4

### 14.3. Specifications electric system truck

Description	Specification	Spierings code	Quantity / Amount
Battery	12 V 225 Ah	AUDI00100225	2x

Table 14-5

### 14.4. Specifications hydraulic system truck

The contents of the hydraulic tank is 550 litres.

#### Maintenance specifications

Description	Specification	Spierings code	Quantity / Amount
Hydraulic oil	ATF III / Fluide G3	OLSM00100040	n.a.
Hydraulic coarse filter	CS-15 AN	HYIN04100211	1x
Hydraulic fine filter	FH-100 Triple R	HYIN04100040	1x
Filter steering system	Gauze filter 2.0008G40-A00-0-M	HYIN04100060	1x

Table 14-6

### 14.5. Specifications pneumatic system truck

Description	Specification	Spierings code	Quantity / Amount
Air dryer filter	Wabco 432 410 222 7	SERV05100010	1x
Oil atomizer	3/8"N New Deal	LUKM03300010	1x
Oil for oil atomizer	Berulit 75	OLSM00400010	

Table 14-7

### 14.6. Specifications lubricants truck

Description	Specification	Spierings code	Quantity / Amount
Refill grease reservoirs automatic lubrication system	EP2 (AVIA Mystiek JT-6)	OLSM03000010	n.a.
Refill grease gun	EP2 (AVIA Mystiek JT-6)	OLSM01500030	n.a.

Table 14-8



## 15. Annexes

<b>TAB 1</b>	<b>Pneumatic scheme</b>
<b>TAB 2</b>	<b>Hydraulic scheme</b>
<b>TAB 3</b>	<b>Electric scheme</b>
<b>TAB 4</b>	<b>Central lubrication system</b>
<b>TAB 5</b>	<b>Information tyres</b>
<b>TAB 6</b>	<b>Error codes steering system</b>
<b>TAB 7</b>	<b>Error codes AStronic</b>
<b>TAB 8</b>	<b>(empty)</b>
<b>TAB 9</b>	<b>(empty)</b>
<b>TAB 10</b>	<b>(empty)</b>

